

CM100RX-24S

HIGH POWER SWITCHING USE
INSULATED TYPE

CM100RX-24S



sevenpack (3φ inverter+Brake)

- 6th Generation NX series -

Collector current I_C 100 A

Collector-emitter voltage V_{CES} 1200 V

Maximum junction temperature T_{jmax} ... 175 °C

- Flat base Type
- Copper base plate (non-plating)
- Tin plating pin terminals
- RoHS Directive compliant
- UL Recognized under UL1557, File E323585

APPLICATION

AC Motor Control, Motion/Servo Control, etc.

OUTLINE DRAWING & INTERNAL CONNECTION

Dimension in mm

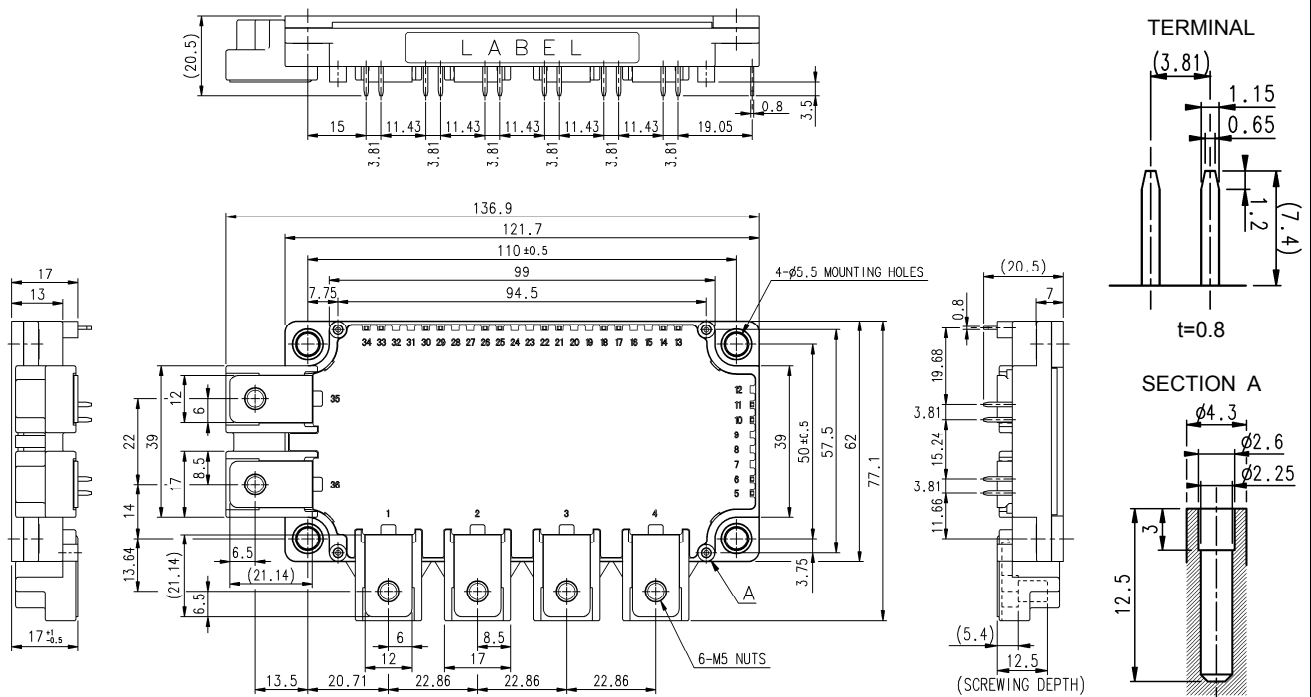

INTERNAL CONNECTION

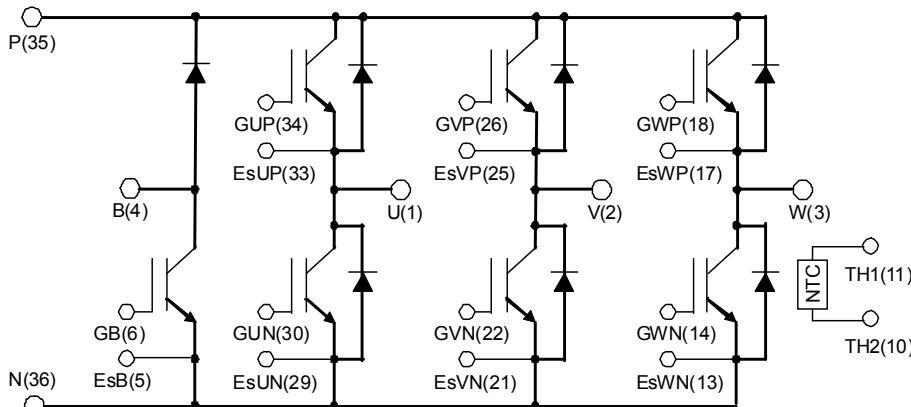

Tolerance otherwise specified

Division of Dimension	Tolerance
0.5 to 3	±0.2
over 3 to 6	±0.3
over 6 to 30	±0.5
over 30 to 120	±0.8
over 120 to 400	±1.2

The Tolerance of size between terminals is assumed to be ±0.4.

ABSOLUTE MAXIMUM RATINGS ($T_j=25\text{ }^\circ\text{C}$, unless otherwise specified)

INVERTER PART IGBT/FWDI

Symbol	Item	Conditions	Rating	Unit
V_{CES}	Collector-emitter voltage	G-E short-circuited	1200	V
V_{GES}	Gate-emitter voltage	C-E short-circuited	± 20	V
I_C	Collector current	DC, $T_C=119\text{ }^\circ\text{C}$ (Note.2)	100	A
I_{CRM}		Pulse (Note.3)	200	
P_{tot}	Total power dissipation	$T_C=25\text{ }^\circ\text{C}$ (Note.2, 4)	750	W
I_E (Note.1)	Emitter current	$T_C=25\text{ }^\circ\text{C}$ (Note.2, 4)	100	A
I_{ERM} (Note.1)		Pulse (Note.3)	200	

BRAKE PART IGBT/CLAMPDI

Symbol	Item	Conditions	Rating	Unit
V_{CES}	Collector-emitter voltage	G-E short-circuited	1200	V
V_{GES}	Gate-emitter voltage	C-E short-circuited	± 20	V
I_C	Collector current	DC, $T_C=125\text{ }^\circ\text{C}$ (Note.2)	50	A
I_{CRM}		Pulse (Note.3)	100	
P_{tot}	Total power dissipation	$T_C=25\text{ }^\circ\text{C}$ (Note.2, 4)	425	W
V_{RRM}	Repetitive peak reverse voltage	G-E short-circuited	1200	V
I_F (Note.1)	Forward current	$T_C=25\text{ }^\circ\text{C}$ (Note.2, 4)	50	A
I_{FRM} (Note.1)		Pulse (Note.3)	100	

MODULE

Symbol	Item	Conditions	Rating	Unit
T_{jmax}	Maximum junction temperature	-	175	$^\circ\text{C}$
T_{Cmax}	Maximum case temperature	(Note.2)	125	
T_{jop}	Operating junction temperature	-	-40 ~ +150	$^\circ\text{C}$
T_{stg}	Storage temperature	-	-40 ~ +125	
V_{isol}	Isolation voltage	Terminals to base plate, RMS, f=60 Hz, AC 1 min	2500	V

ELECTRICAL CHARACTERISTICS ($T_j=25\text{ }^\circ\text{C}$, unless otherwise specified)

INVERTER PART IGBT/FWDI

Symbol	Item	Conditions	Limits			Unit	
			Min.	Typ.	Max.		
I_{CES}	Collector-emitter cut-off current	$V_{CE}=V_{CES}$, G-E short-circuited	-	-	1	mA	
I_{GES}	Gate-emitter leakage current	$V_{GE}=V_{GES}$, C-E short-circuited	-	-	0.5	μA	
$V_{GE(th)}$	Gate-emitter threshold voltage	$I_C=10\text{ mA}$, $V_{CE}=10\text{ V}$	5.4	6.0	6.6	V	
V_{CESat} (Terminal)	Collector-emitter saturation voltage	$I_C=100\text{ A}$ (Note.5), $V_{GE}=15\text{ V}$	$T_j=25\text{ }^\circ\text{C}$	-	1.80	2.25	V
			$T_j=125\text{ }^\circ\text{C}$	-	2.00	-	
			$T_j=150\text{ }^\circ\text{C}$	-	2.05	-	
V_{CESat} (Chip)	Collector-emitter saturation voltage	$I_C=100\text{ A}$ (Note.5), $V_{GE}=15\text{ V}$	$T_j=25\text{ }^\circ\text{C}$	-	1.70	2.15	V
			$T_j=125\text{ }^\circ\text{C}$	-	1.90	-	
			$T_j=150\text{ }^\circ\text{C}$	-	1.95	-	
C_{ies}	Input capacitance	$V_{CE}=10\text{ V}$, G-E short-circuited	-	-	10	nF	
C_{oes}	Output capacitance		-	-	2.0		
C_{res}	Reverse transfer capacitance		-	-	0.17		
Q_G	Gate charge	$V_{CC}=600\text{ V}$, $I_C=100\text{ A}$, $V_{GE}=15\text{ V}$	-	233	-	nC	
$t_{d(on)}$	Turn-on delay time	$V_{CC}=600\text{ V}$, $I_C=100\text{ A}$, $V_{GE}=\pm 15\text{ V}$, $R_G=6.2\ \Omega$, Inductive load	-	-	300	ns	
t_r	Rise time		-	-	200		
$t_{d(off)}$	Turn-off delay time		-	-	600		
t_f	Fall time		-	-	300		
V_{EC} (Note.1) (Terminal)	Emitter-collector voltage	$I_E=100\text{ A}$ (Note.5), G-E short-circuited	$T_j=25\text{ }^\circ\text{C}$	-	1.8	2.25	V
			$T_j=125\text{ }^\circ\text{C}$	-	1.8	-	
			$T_j=150\text{ }^\circ\text{C}$	-	1.8	-	
V_{EC} (Note.1) (Chip)	Emitter-collector voltage	$I_E=100\text{ A}$ (Note.5), G-E short-circuited	$T_j=25\text{ }^\circ\text{C}$	-	1.7	2.15	V
			$T_j=125\text{ }^\circ\text{C}$	-	1.7	-	
			$T_j=150\text{ }^\circ\text{C}$	-	1.7	-	

ELECTRICAL CHARACTERISTICS (cont.; $T_j=25\text{ }^\circ\text{C}$, unless otherwise specified)**INVERTER PART IGBT/FWDI**

Symbol	Item	Conditions	Limits			Unit
			Min.	Typ.	Max.	
t_{rr} (Note.1)	Reverse recovery time	$V_{CC}=600\text{ V}$, $I_E=100\text{ A}$, $V_{GE}=\pm 15\text{ V}$,	-	-	300	ns
Q_{rr} (Note.1)	Reverse recovery charge	$R_G=6.2\ \Omega$, Inductive load	-	5.3	-	μC
E_{on}	Turn-on switching energy per pulse	$V_{CC}=600\text{ V}$, $I_C=I_E=100\text{ A}$,	-	8.6	-	mJ
E_{off}	Turn-off switching energy per pulse	$V_{GE}=\pm 15\text{ V}$, $R_G=6.2\ \Omega$, $T_j=150\text{ }^\circ\text{C}$,	-	10.7	-	
E_{rr} (Note.1)	Reverse recovery energy per pulse	Inductive load	-	10.2	-	mJ
R_{CC+EE}	Internal lead resistance	Main terminals-chip, per switch, $T_C=25\text{ }^\circ\text{C}$ (Note.2)	-	-	2.2	m Ω
r_g	Internal gate resistance	Per switch	-	0	-	Ω

BRAKE PART IGBT/CLAMPDi

Symbol	Item	Conditions	Limits			Unit	
			Min.	Typ.	Max.		
I_{CES}	Collector-emitter cut-off current	$V_{CE}=V_{CES}$, G-E short-circuited	-	-	1	mA	
I_{GES}	Gate-emitter leakage current	$V_{GE}=V_{GES}$, C-E short-circuited	-	-	0.5	μA	
$V_{GE(th)}$	Gate-emitter threshold voltage	$I_C=5\text{ mA}$, $V_{CE}=10\text{ V}$	5.4	6.0	6.6	V	
V_{CESat} (Terminal)	Collector-emitter saturation voltage	$I_C=50\text{ A}$ (Note.5), $V_{GE}=15\text{ V}$	$T_j=25\text{ }^\circ\text{C}$	-	1.80	2.25	V
			$T_j=125\text{ }^\circ\text{C}$	-	2.00	-	
			$T_j=150\text{ }^\circ\text{C}$	-	2.05	-	
V_{CESat} (Chip)	Collector-emitter saturation voltage	$I_C=50\text{ A}$ (Note.5), $V_{GE}=15\text{ V}$	$T_j=25\text{ }^\circ\text{C}$	-	1.70	2.15	V
			$T_j=125\text{ }^\circ\text{C}$	-	1.90	-	
			$T_j=150\text{ }^\circ\text{C}$	-	1.95	-	
C_{ies}	Input capacitance	$V_{CE}=10\text{ V}$, G-E short-circuited	-	-	5.0	nF	
C_{oes}	Output capacitance		-	-	1.0		
C_{res}	Reverse transfer capacitance		-	-	0.08		
Q_G	Gate charge	$V_{CC}=600\text{ V}$, $I_C=50\text{ A}$, $V_{GE}=15\text{ V}$	-	117	-	nC	
$t_{d(on)}$	Turn-on delay time	$V_{CC}=600\text{ V}$, $I_C=50\text{ A}$, $V_{GE}=\pm 15\text{ V}$,	-	-	300	ns	
t_r	Rise time		-	-	200		
$t_{d(off)}$	Turn-off delay time		$R_G=13\ \Omega$, Inductive load	-	-		600
t_f	Fall time			-	-		300
I_{RRM}	Repetitive peak reverse current	$V_R=V_{RRM}$, G-E short-circuited	-	-	1	mA	
V_F (Terminal)	Forward voltage	$I_F=50\text{ A}$ (Note.5), G-E short-circuited	$T_j=25\text{ }^\circ\text{C}$	-	1.8	2.25	V
			$T_j=125\text{ }^\circ\text{C}$	-	1.8	-	
			$T_j=150\text{ }^\circ\text{C}$	-	1.8	-	
V_F (Chip)	Forward voltage	$I_F=50\text{ A}$ (Note.5), G-E short-circuited	$T_j=25\text{ }^\circ\text{C}$	-	1.7	2.15	V
			$T_j=125\text{ }^\circ\text{C}$	-	1.7	-	
			$T_j=150\text{ }^\circ\text{C}$	-	1.7	-	
t_{rr}	Reverse recovery time	$V_{CC}=600\text{ V}$, $I_F=50\text{ A}$, $V_{GE}=\pm 15\text{ V}$,	-	-	300	ns	
Q_{rr}	Reverse recovery charge	$R_G=13\ \Omega$, Inductive load	-	2.7	-	μC	
E_{on}	Turn-on switching energy per pulse	$V_{CC}=600\text{ V}$, $I_C=I_F=50\text{ A}$,	-	5.5	-	mJ	
E_{off}	Turn-off switching energy per pulse	$V_{GE}=\pm 15\text{ V}$, $R_G=13\ \Omega$, $T_j=150\text{ }^\circ\text{C}$,	-	5.3	-		
E_{rr}	Reverse recovery energy per pulse	Inductive load	-	4.5	-	mJ	
r_g	Internal gate resistance	-	-	0	-	Ω	

NTC THERMISTOR PART

Symbol	Item	Conditions	Limits			Unit
			Min.	Typ.	Max.	
R_{25}	Zero power resistance	$T_C=25\text{ }^\circ\text{C}$ (Note.2)	4.85	5.00	5.15	k Ω
$\Delta R/R$	Deviation of resistance	$T_C=100\text{ }^\circ\text{C}$, $R_{100}=493\ \Omega$	-7.3	-	+7.8	%
$B_{(25/50)}$	B constant	Approximate by equation (Note.6)	-	3375	-	K
P_{25}	Power dissipation	$T_C=25\text{ }^\circ\text{C}$ (Note.2)	-	-	10	mW

THERMAL RESISTANCE CHARACTERISTICS

Symbol	Item	Conditions	Limits			Unit
			Min.	Typ.	Max.	
$R_{th(j-c)Q}$	Thermal resistance (Note. 2)	Junction to case, per Inverter IGBT	-	-	0.20	K/W
$R_{th(j-c)D}$		Junction to case, per Inverter FWDi	-	-	0.29	
$R_{th(j-c)Q}$		Junction to case, per Brake IGBT	-	-	0.35	K/W
$R_{th(j-c)D}$		Junction to case, per Brake ClampDi	-	-	0.63	
$R_{th(c-s)}$	Contact thermal resistance (Note.2)	Case to heat sink, per 1 module, Thermal grease applied (Note.7)	-	15	-	K/KW

MECHANICAL CHARACTERISTICS

Symbol	Item	Conditions	Limits			Unit
			Min.	Typ.	Max.	
M_t	Mounting torque	Main terminals M 5 screw	2.5	3.0	3.5	N·m
M_s		Mounting to heat sink M 5 screw	2.5	3.0	3.5	
d_s	Creepage distance	Terminal to terminal	10.25	-	-	mm
		Terminal to base plate	12.32	-	-	
d_a	Clearance	Terminal to terminal	10.28	-	-	mm
		Terminal to base plate	10.85	-	-	
m	Weight	-	-	370	-	g
e_c	Flatness of base plate	On the centerline X, Y (Note.8)	±0	-	+100	µm

Note.1: Represent ratings and characteristics of the anti-parallel, emitter-collector free wheeling diode (FWDi).

Note.2: Case temperature (T_c) and heat sink temperature (T_s) are defined on the each surface (mounting side) of base plate and heat sink just under the chips. Refer to the figure of chip location.
The heat sink thermal resistance should measure just under the chips.

Note.3: Pulse width and repetition rate should be such that the device junction temperature (T_j) dose not exceed T_{jmax} rating.

Note.4: Junction temperature (T_j) should not increase beyond T_{jmax} rating.

Note.5: Pulse width and repetition rate should be such as to cause negligible temperature rise.
Refer to the figure of test circuit.

Note.6: $B_{(25/50)} = \ln\left(\frac{R_{25}}{R_{50}}\right) / \left(\frac{1}{T_{25}} - \frac{1}{T_{50}}\right)$,

R_{25} : resistance at absolute temperature T_{25} [K]; $T_{25}=25 [^{\circ}C]+273.15=298.15$ [K]

R_{50} : resistance at absolute temperature T_{50} [K]; $T_{50}=50 [^{\circ}C]+273.15=323.15$ [K]

Note.7: Typical value is measured by using thermally conductive grease of $\lambda=0.9$ W/(m·K).

Note.8: The base plate (mounting side) flatness measurement points (X, Y) are as follows of the following figure.

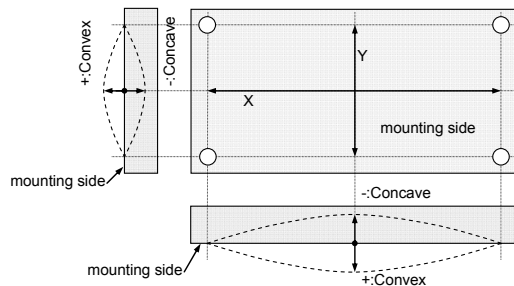

Note.9: Japan Electronics and Information Technology Industries Association (JEITA) standards,

"EIAJ ED-4701/300: Environmental and endurance test methods for semiconductor devices (Stress test I)"

Note.10: Use the following screws when mounting the printed circuit board (PCB) on the stand offs.

"M2.6×10 or M2.6×12 self tapping screw"

The length of the screw depends on the thickness of the PCB.

RECOMMENDED OPERATING CONDITIONS ($T_a=25$ °C, unless otherwise specified)

Symbol	Item	Conditions	Limits			Unit	
			Min.	Typ.	Max.		
V_{CC}	DC supply voltage	Applied across P-N terminals	-	600	850	V	
V_{GEon}	Gate-emitter drive voltage	Applied across GB-EsB / G*P-Es*P, G*N-Es*N terminals	13.5	15.0	16.5	V	
R_G	External gate resistance	Per switch	Inverter IGBT	6.2	-	62	Ω
			Brake IGBT	13	-	130	

MITSUBISHI IGBT MODULES
CM100RX-24S
 HIGH POWER SWITCHING USE
 INSULATED TYPE

CHIP LOCATION (top view)

Dimension in mm, Tolerance: ±1 mm

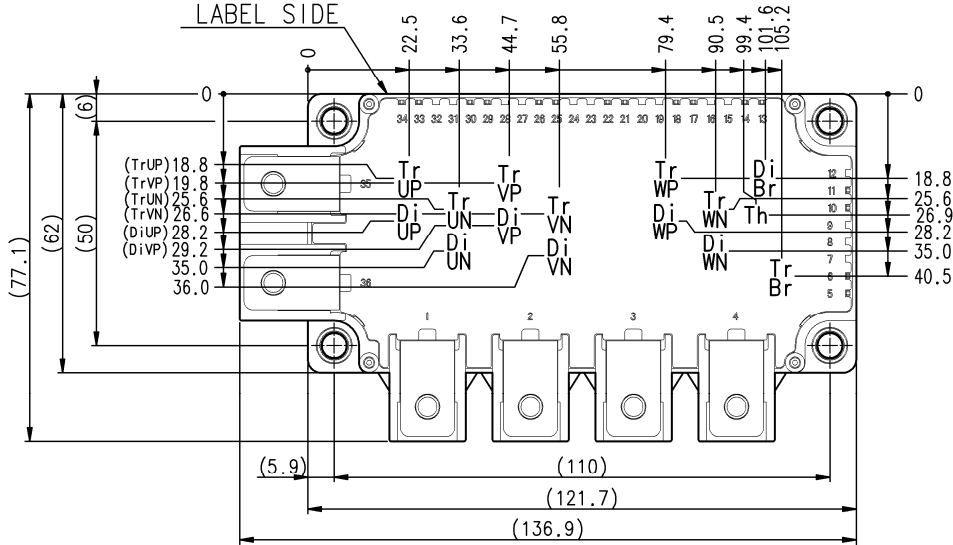

Tr*P/Tr*N/TrBr: IGBT, Di*P/Di*N: FWDi, DiBr: ClampDi, Th: NTC thermistor.

TEST CIRCUIT AND WAVEFORMS

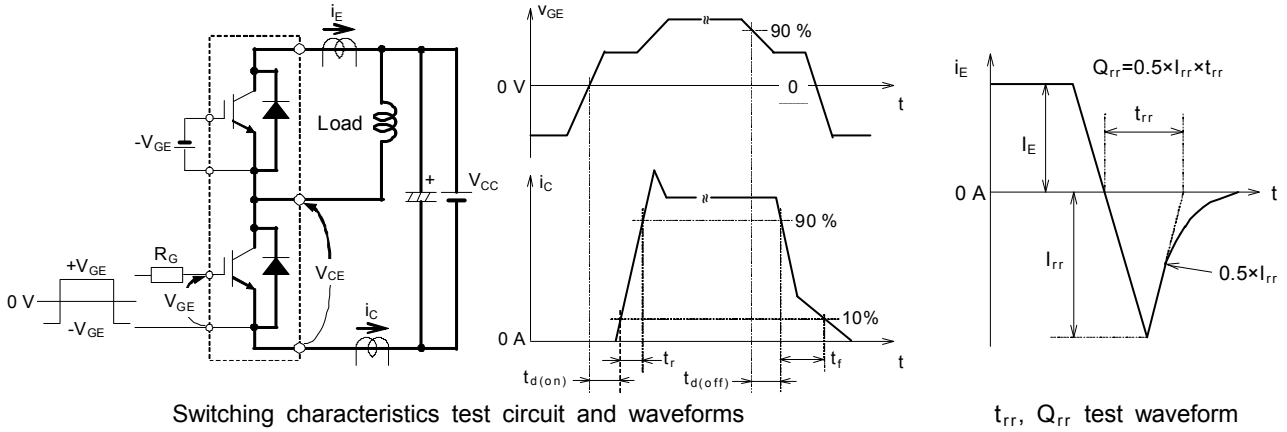

Switching characteristics test circuit and waveforms

t_{rr}, Q_{rr} test waveform

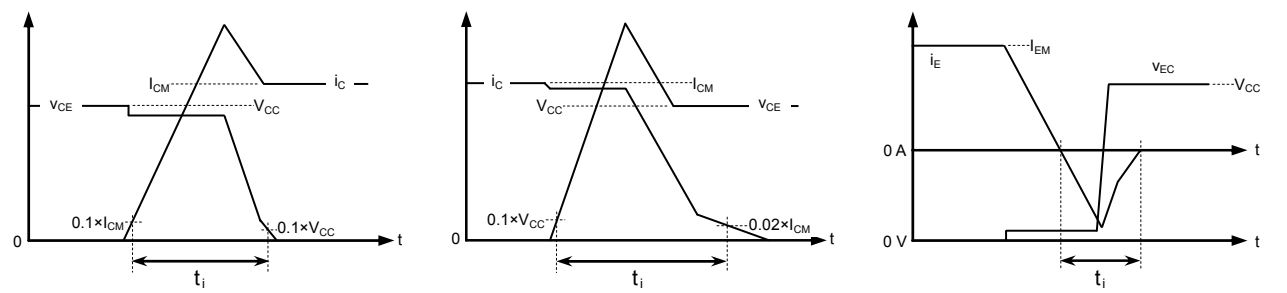

IGBT Turn-on switching energy

IGBT Turn-off switching energy

FWDi Reverse recovery energy

Turn-on / Turn-off switching energy and Reverse recovery energy test waveforms (Integral time instruction drawing)

TEST CIRCUIT

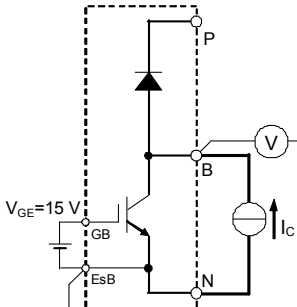
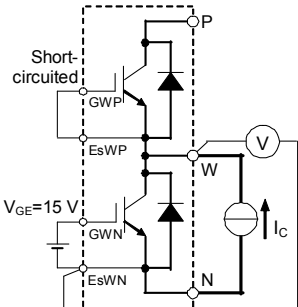
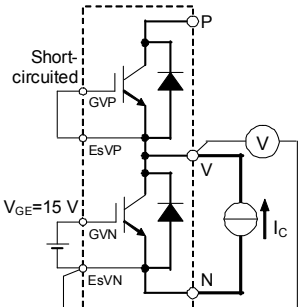
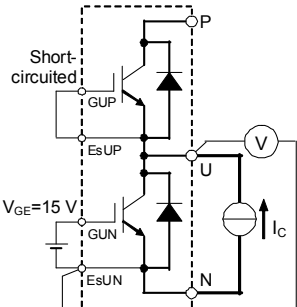
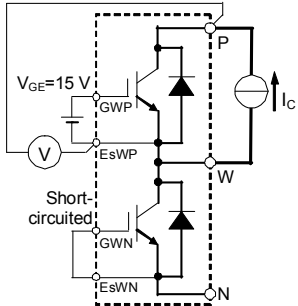
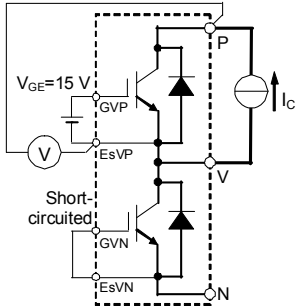
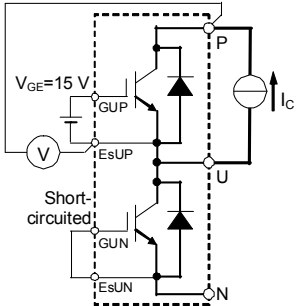

Gate-emitter short-circuited
 UP / UN IGBT

Gate-emitter short-circuited
 VP / VN IGBT

Gate-emitter short-circuited
 WP / WN IGBT

Gate-emitter short-circuited
 Brake IGBT

V_{CEsat} test circuit

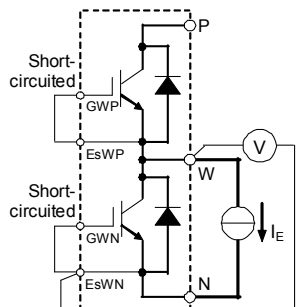
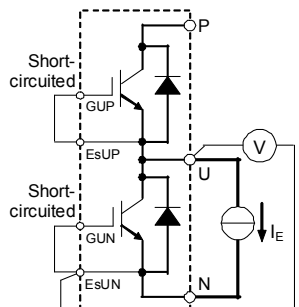
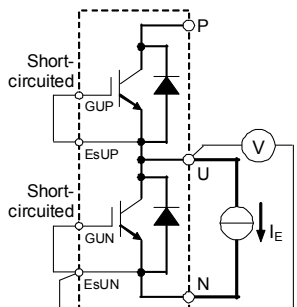
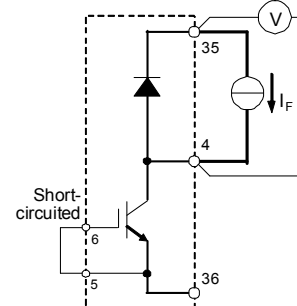
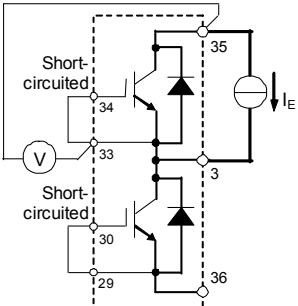
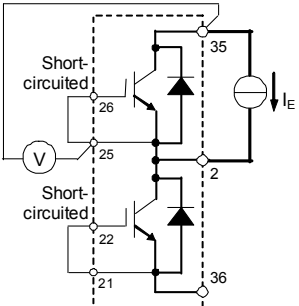
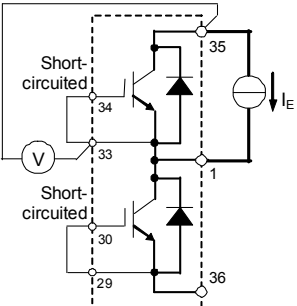

Gate-emitter short-circuited
 UP / UN FWDi

Gate-emitter short-circuited
 VP / VN FWDi

Gate-emitter short-circuited
 WP / WN FWDi

Gate-emitter short-circuited
 Brake ClampDi

V_{EC} / V_F test circuit

PERFORMANCE CURVES

INVERTER PART

OUTPUT CHARACTERISTICS (TYPICAL)

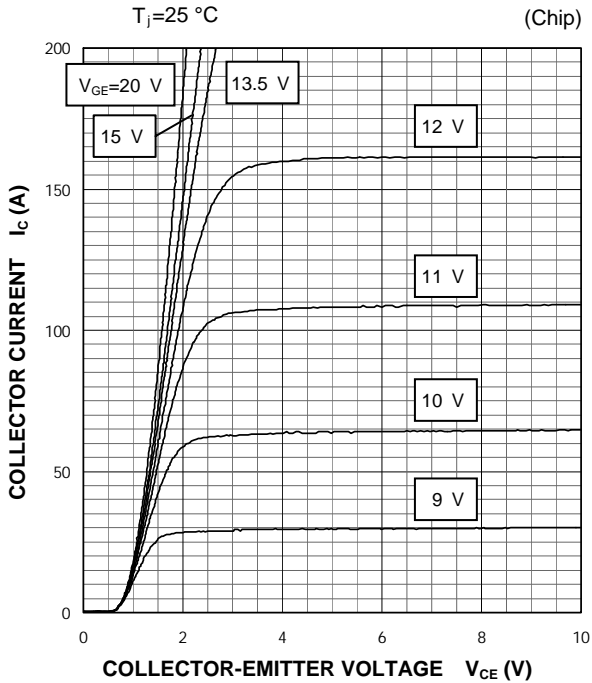

COLLECTOR-EMITTER SATURATION VOLTAGE CHARACTERISTICS (TYPICAL)

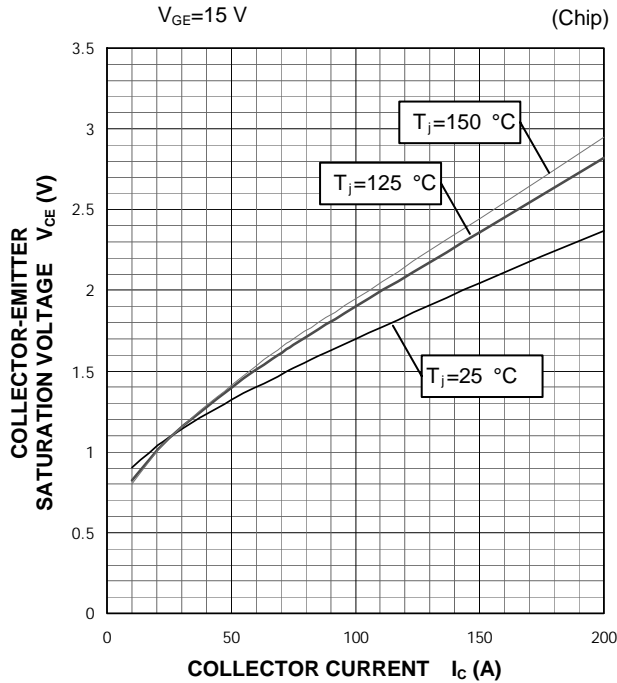

COLLECTOR-EMITTER SATURATION VOLTAGE CHARACTERISTICS (TYPICAL)

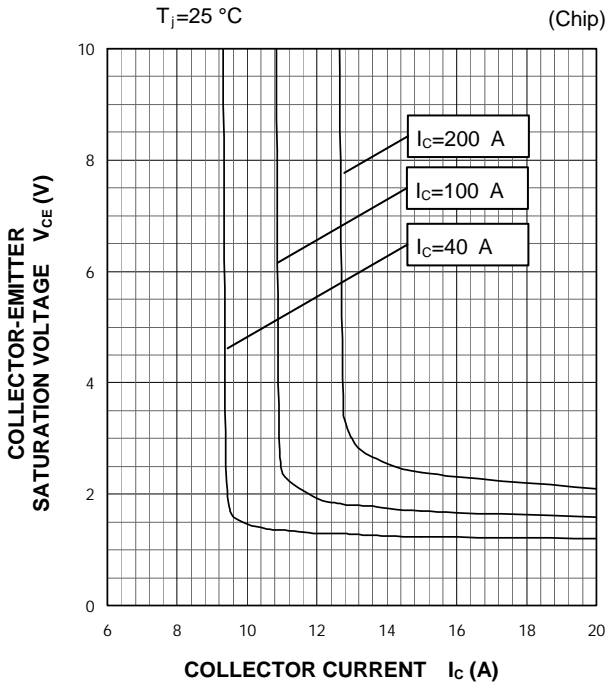

FREE WHEELING DIODE FORWARD CHARACTERISTICS (TYPICAL)

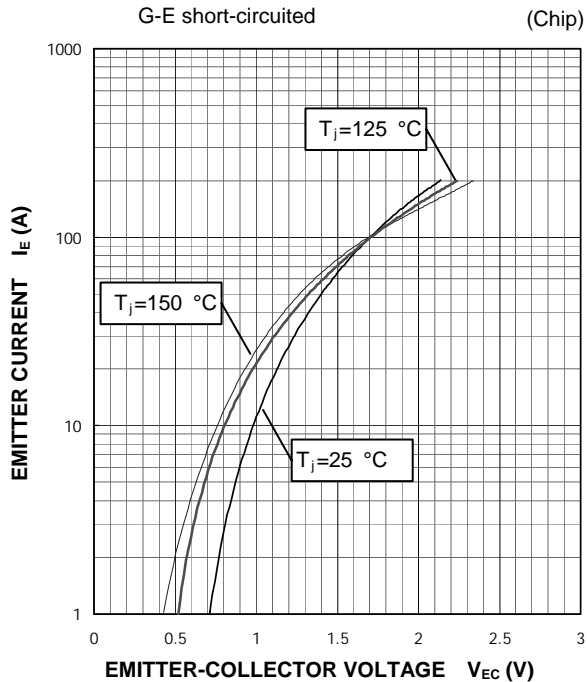

HALF-BRIDGE SWITCHING CHARACTERISTICS (TYPICAL)

$V_{CC}=600\text{ V}$, $V_{GE}=\pm 15\text{ V}$, $R_G=6.2\ \Omega$,
 ———: $T_j=150\text{ }^\circ\text{C}$, - - - - -: $T_j=125\text{ }^\circ\text{C}$

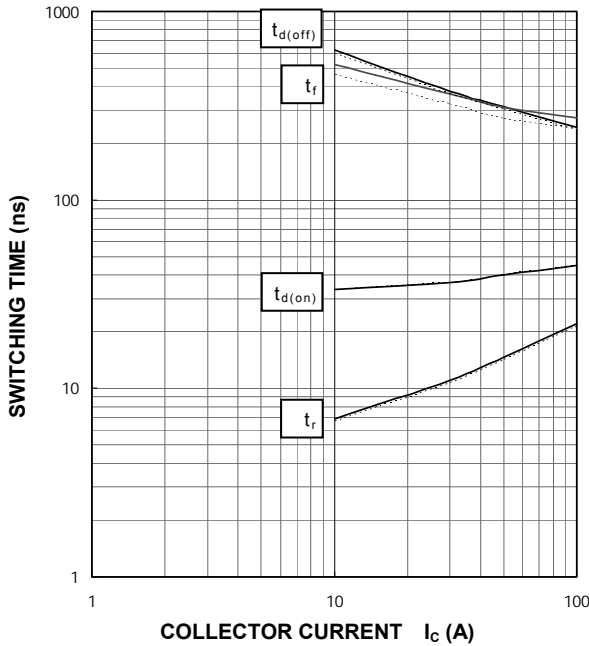

HALF-BRIDGE SWITCHING CHARACTERISTICS (TYPICAL)

$V_{CC}=600\text{ V}$, $V_{GE}=\pm 15\text{ V}$, $I_c=100\text{ A}$,
 ———: $T_j=150\text{ }^\circ\text{C}$, - - - - -: $T_j=125\text{ }^\circ\text{C}$

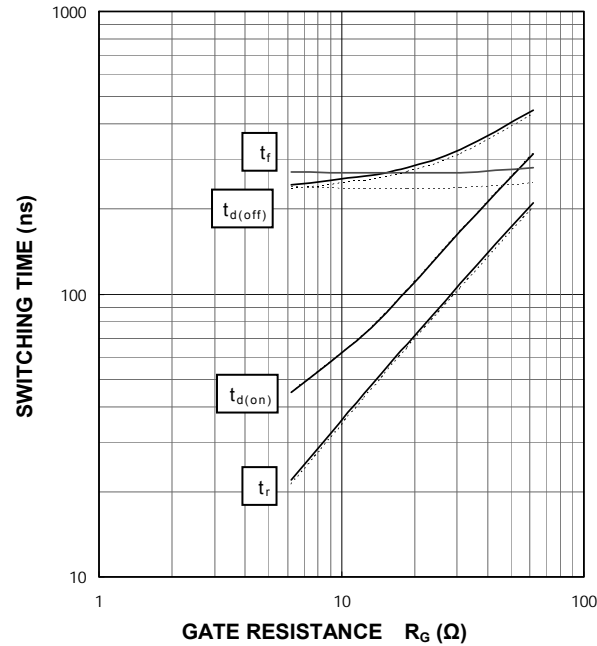

HALF-BRIDGE SWITCHING CHARACTERISTICS (TYPICAL)

$V_{CC}=600\text{ V}$, $V_{GE}=\pm 15\text{ V}$, $R_G=6.2\ \Omega$,
 ———: $T_j=150\text{ }^\circ\text{C}$, - - - - -: $T_j=125\text{ }^\circ\text{C}$

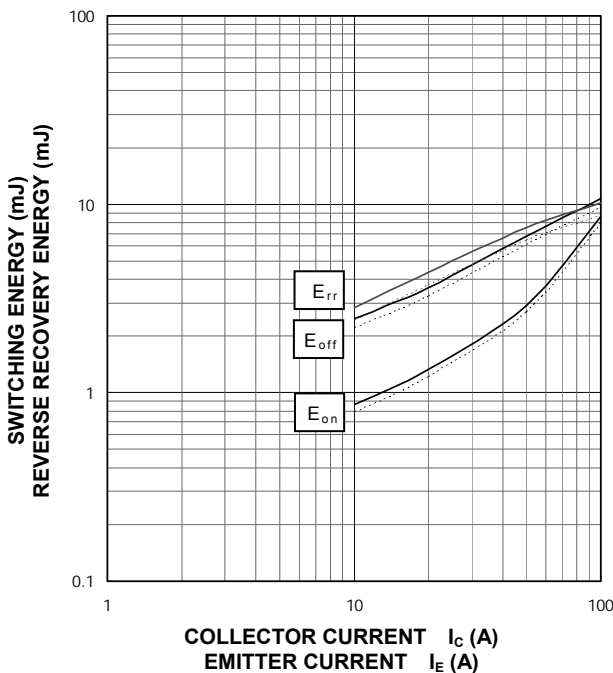

HALF-BRIDGE SWITCHING CHARACTERISTICS (TYPICAL)

$V_{CC}=600\text{ V}$, $V_{GE}=\pm 15\text{ V}$, $I_c=100\text{ A}$,
 ———: $T_j=150\text{ }^\circ\text{C}$, - - - - -: $T_j=125\text{ }^\circ\text{C}$

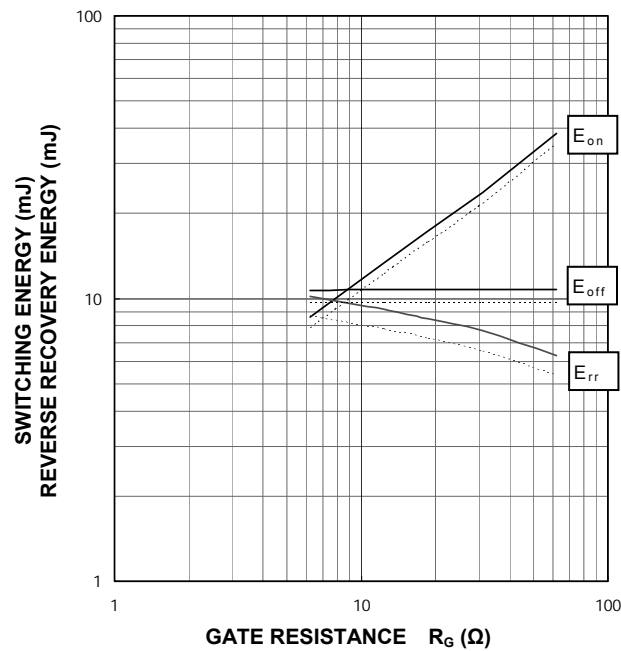

**CAPACITANCE CHARACTERISTICS
 (TYPICAL)**

G-E short-circuited, $T_j=25\text{ }^\circ\text{C}$

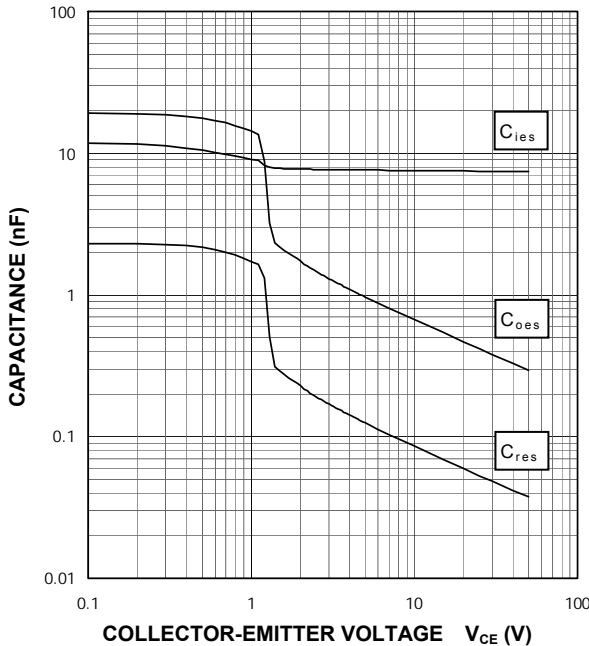

**FREE WHEELING DIODE
 REVERSE RECOVERY CHARACTERISTICS
 (TYPICAL)**

$V_{CC}=600\text{ V}$, $V_{GE}=\pm 15\text{ V}$, $R_G=6.2\ \Omega$,
 —: $T_j=150\text{ }^\circ\text{C}$, - - - : $T_j=125\text{ }^\circ\text{C}$

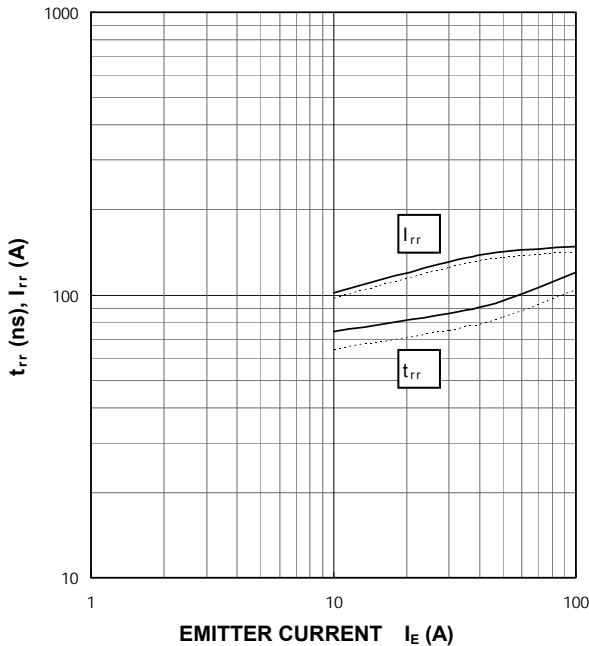

**GATE CHARGE CHARACTERISTICS
 (TYPICAL)**

$V_{CC}=600\text{ V}$, $I_C=100\text{ A}$, $T_j=25\text{ }^\circ\text{C}$

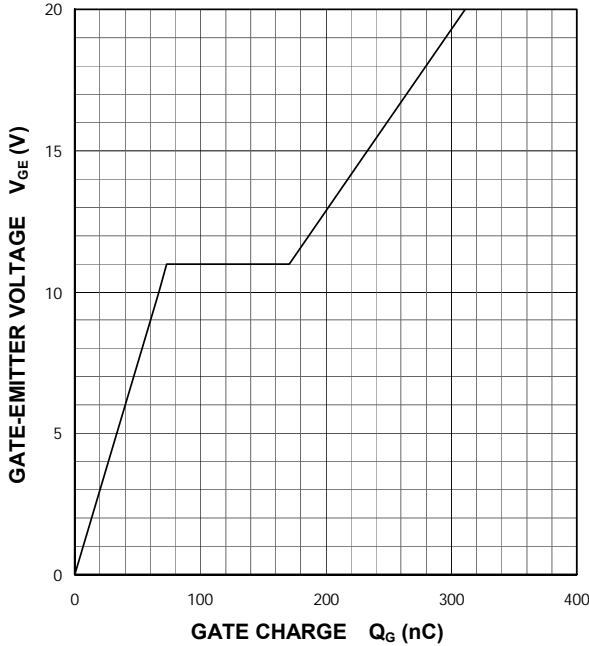

**TRANSIENT THERMAL IMPEDANCE
 CHARACTERISTICS
 (MAXIMUM)**

Single pulse, $T_C=25\text{ }^\circ\text{C}$

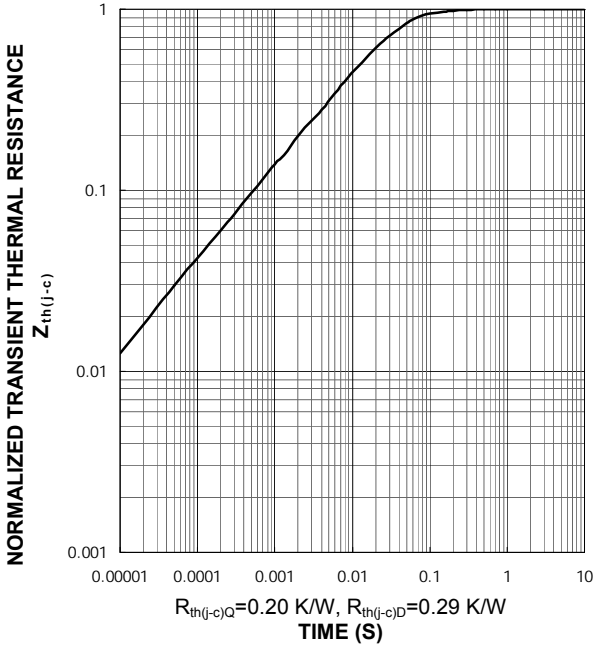

BRAKE PART

COLLECTOR-EMITTER SATURATION VOLTAGE CHARACTERISTICS (TYPICAL)

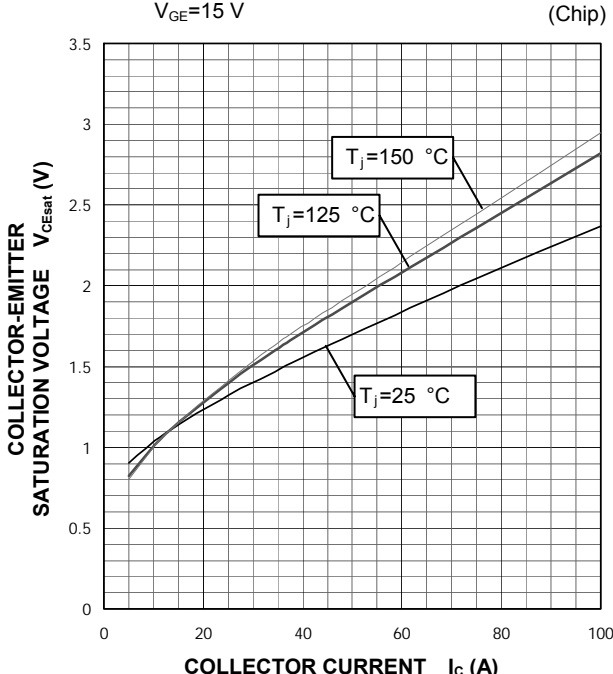

CLAMP DIODE FORWARD CHARACTERISTICS (TYPICAL)

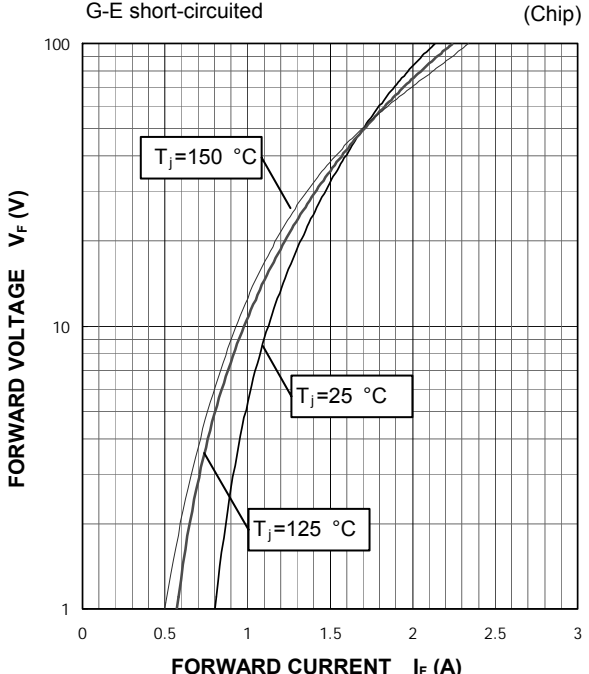

HALF-BRIDGE SWITCHING CHARACTERISTICS (TYPICAL)

$V_{CC}=600\text{ V}$, $V_{GE}=\pm 15\text{ V}$, $R_G=13\ \Omega$, INDUCTIVE LOAD
 ———: $T_j=150\text{ }^\circ\text{C}$, - - - - -: $T_j=125\text{ }^\circ\text{C}$

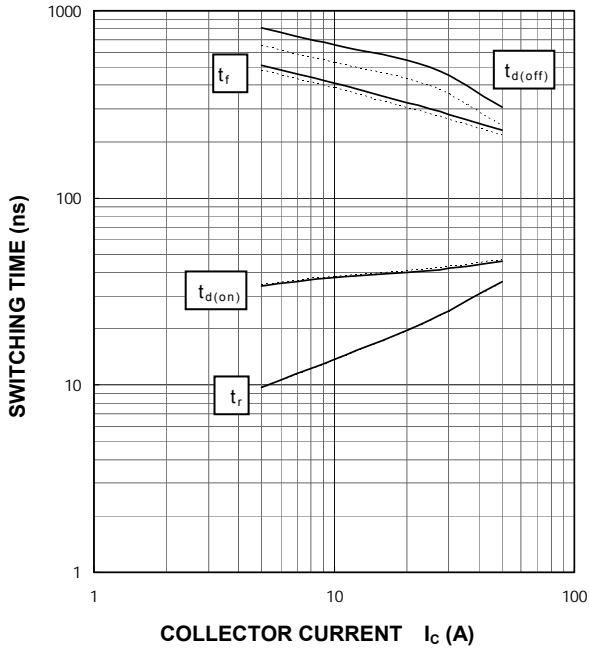

HALF-BRIDGE SWITCHING CHARACTERISTICS (TYPICAL)

$V_{CC}=600\text{ V}$, $I_c=50\text{ A}$, $V_{GE}=\pm 15\text{ V}$, INDUCTIVE LOAD
 ———: $T_j=150\text{ }^\circ\text{C}$, - - - - -: $T_j=125\text{ }^\circ\text{C}$

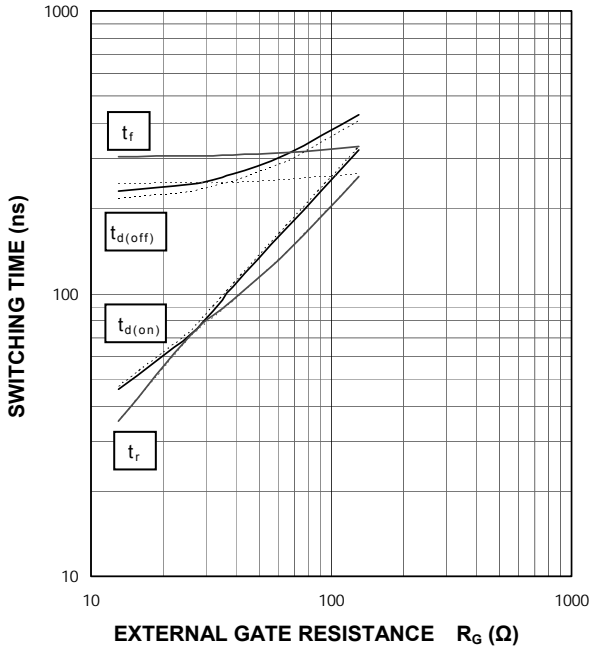

HALF-BRIDGE SWITCHING CHARACTERISTICS (TYPICAL)
 $V_{CC}=600\text{ V}$, $V_{GE}=\pm 15\text{ V}$, $R_G=13\ \Omega$,
 INDUCTIVE LOAD, PER PULSE
 ———: $T_j=150\text{ }^\circ\text{C}$, - - - - -: $T_j=125\text{ }^\circ\text{C}$

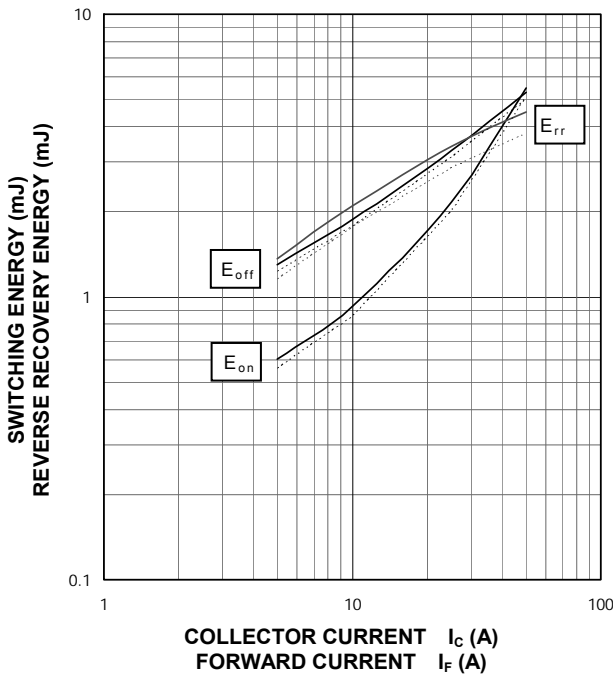

HALF-BRIDGE SWITCHING CHARACTERISTICS (TYPICAL)
 $V_{CC}=600\text{ V}$, $I_C/I_F=50\text{ A}$, $V_{GE}=\pm 15\text{ V}$,
 INDUCTIVE LOAD, PER PULSE
 ———: $T_j=150\text{ }^\circ\text{C}$, - - - - -: $T_j=125\text{ }^\circ\text{C}$

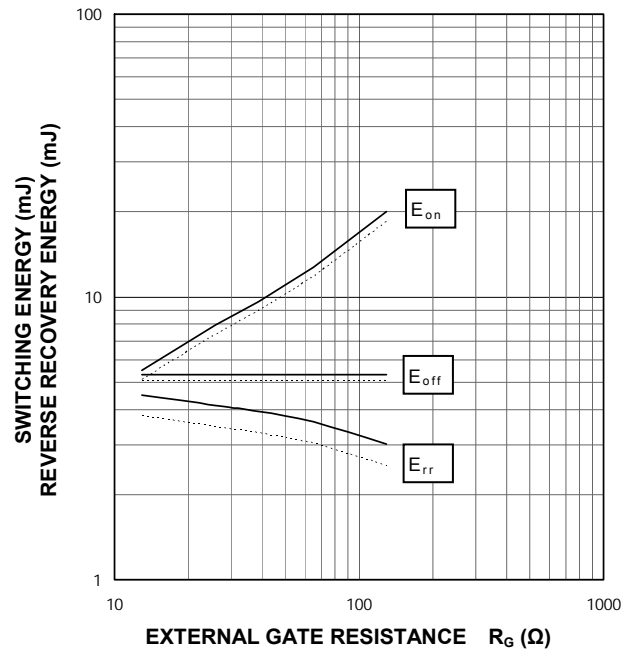

CLAMP DIODE REVERSE RECOVERY CHARACTERISTICS (TYPICAL)
 $V_{CC}=600\text{ V}$, $V_{GE}=\pm 15\text{ V}$, $R_G=13\ \Omega$, INDUCTIVE LOAD
 ———: $T_j=150\text{ }^\circ\text{C}$, - - - - -: $T_j=125\text{ }^\circ\text{C}$

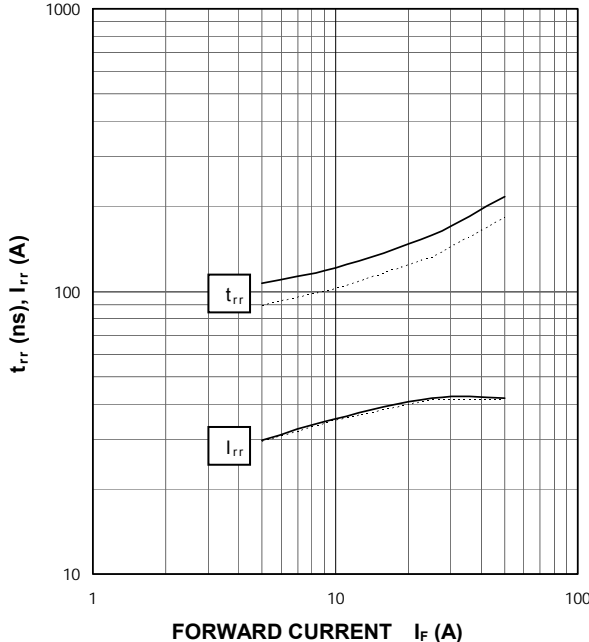

TRANSIENT THERMAL IMPEDANCE CHARACTERISTICS (MAXIMUM)
 Single pulse, $T_C=25\text{ }^\circ\text{C}$

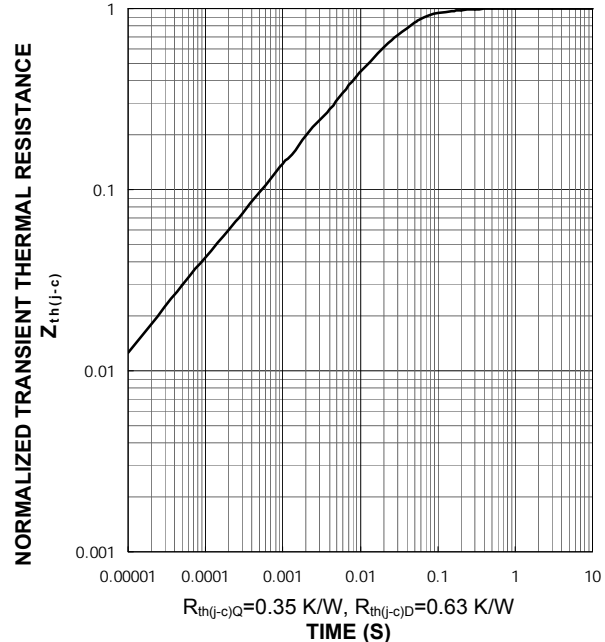

Keep safety first in your circuit designs!

· Mitsubishi Electric Corporation puts the maximum effort into making semiconductor products better and more reliable, but there is always the possibility that trouble may occur with them. Trouble with semiconductors may lead to personal injury, fire or property damage.

Remember to give due consideration to safety when making your circuit designs, with appropriate measures such as (i) placement of substitutive, auxiliary circuits, (ii) use of non-flammable material or (iii) prevention against any malfunction or mishap.

Notes regarding these materials

- These materials are intended as a reference to assist our customers in the selection of the Mitsubishi semiconductor product best suited to the customer's application; they do not convey any license under any intellectual property rights, or any other rights, belonging to Mitsubishi Electric Corporation or a third party.
- Mitsubishi Electric Corporation assumes no responsibility for any damage, or infringement of any third-party's rights, originating in the use of any product data, diagrams, charts, programs, algorithms, or circuit application examples contained in these materials.
- All information contained in these materials, including product data, diagrams, charts, programs and algorithms represents information on products at the time of publication of these materials, and are subject to change by Mitsubishi Electric Corporation without notice due to product improvements or other reasons. It is therefore recommended that customers contact Mitsubishi Electric Corporation or an authorized Mitsubishi Semiconductor product distributor for the latest product information before purchasing a product listed herein. The information described here may contain technical inaccuracies or typographical errors. Mitsubishi Electric Corporation assumes no responsibility for any damage, liability, or other loss rising from these inaccuracies or errors. Please also pay attention to information published by Mitsubishi Electric Corporation by various means, including the Mitsubishi Semiconductor home page (<http://www.mitsubishichips.com/Global/index.html>).
- When using any or all of the information contained in these materials, including product data, diagrams, charts, programs, and algorithms, please be sure to evaluate all information as a total system before making a final decision on the applicability of the information and products. Mitsubishi Electric Corporation assumes no responsibility for any damage, liability or other loss resulting from the information contained herein.
- Mitsubishi Electric Corporation semiconductors are not designed or manufactured for use in a device or system that is used under circumstances in which human life is potentially at stake. Please contact Mitsubishi Electric Corporation or an authorized Mitsubishi Semiconductor product distributor when considering the use of a product contained herein for any specific purposes, such as apparatus or systems for transportation, vehicular, medical, aerospace, nuclear, or undersea repeater use.
- The prior written approval of Mitsubishi Electric Corporation is necessary to reprint or reproduce in whole or in part these materials.
- If these products or technologies are subject to the Japanese export control restrictions, they must be exported under a license from the Japanese government and cannot be imported into a country other than the approved destination. Any diversion or reexport contrary to the export control laws and regulations of Japan and/or the country of destination is prohibited.
- Please contact Mitsubishi Electric Corporation or an authorized Mitsubishi Semiconductor product distributor for further details on these materials or the products contained therein.