

< IGBT MODULES >

# CM200EXS-24S

HIGH POWER SWITCHING USE  
INSULATED TYPE

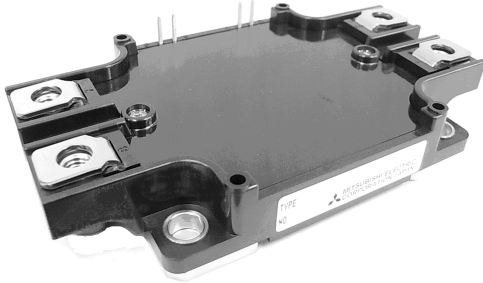

Single switch

Collector current  $I_C$  ..... **200 A**  
 Collector-emitter voltage  $V_{CES}$  ..... **1200 V**  
 Maximum junction temperature  $T_{jmax}$  ..... **175 °C**

- Flat base Type
- Copper base plate (non-plating)
- Tin plating pin terminals
- RoHS Directive compliant
- Recognized under UL1557, File E323585

## APPLICATION

Brake

## OUTLINE DRAWING & INTERNAL CONNECTION

Dimension in mm

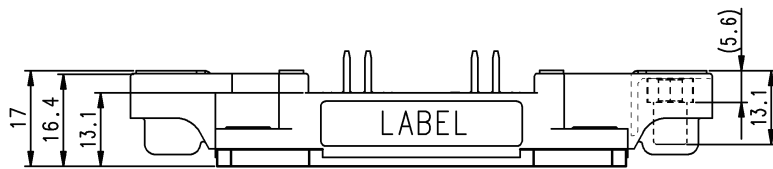
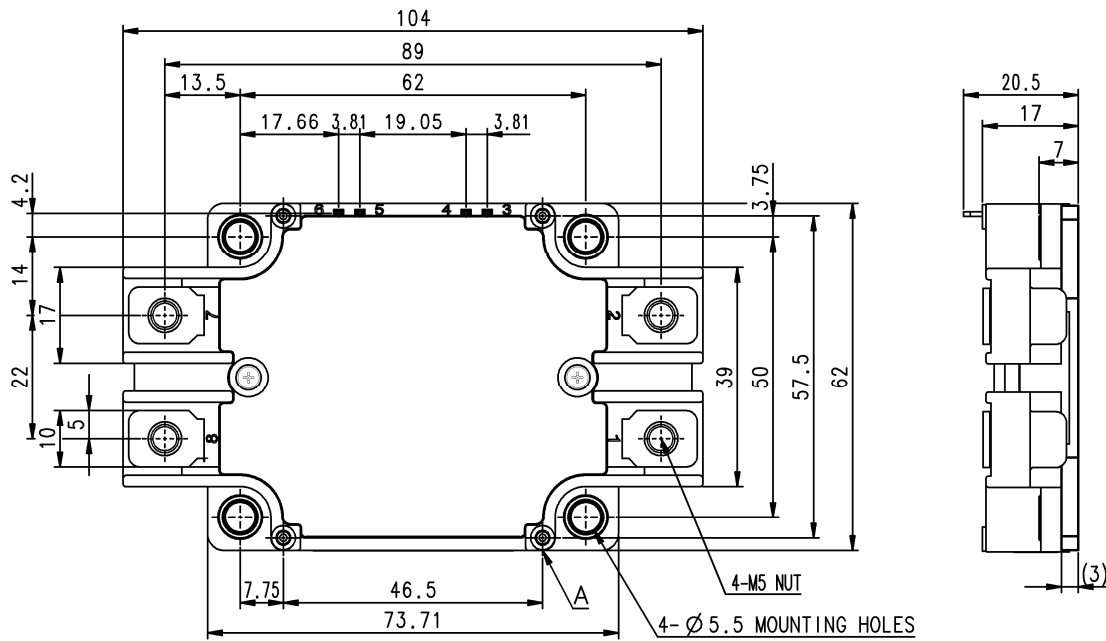

TERMINAL

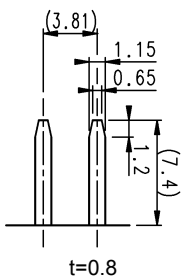

SECTION A

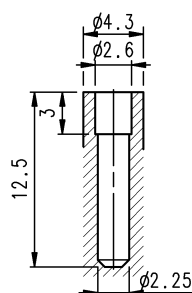

Tolerance otherwise specified

Division of Dimension	Tolerance
0.5 to 3	±0.2
over 3 to 6	±0.3
over 6 to 30	±0.5
over 30 to 120	±0.8
over 120 to 400	±1.2

The tolerance of size between terminals is assumed to be ±0.4.

### INTERNAL CONNECTION

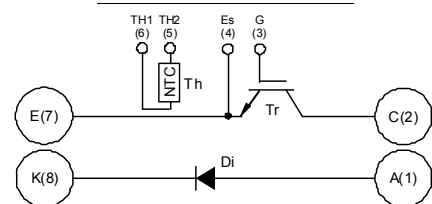

< IGBT MODULES >

CM200EXS-24S

HIGH POWER SWITCHING USE  
INSULATED TYPE

**ABSOLUTE MAXIMUM RATINGS (T<sub>j</sub>=25 °C, unless otherwise specified)**

**IGBT**

Symbol	Item	Conditions	Rating	Unit
V <sub>CES</sub>	Collector-emitter voltage	G-E short-circuited	1200	V
V <sub>GES</sub>	Gate-emitter voltage	C-E short-circuited	± 20	V
I <sub>C</sub>	Collector current	DC, T <sub>C</sub> =119 °C (Note1, 3)	200	A
I <sub>CRM</sub>		Pulse, Repetitive (Note2)	400	
P <sub>tot</sub>	Total power dissipation	T <sub>C</sub> =25 °C (Note1, 3)	1500	W

**DIODE**

Symbol	Item	Conditions	Rating	Unit
V <sub>RRM</sub>	Repetitive peak reverse voltage	-	1200	V
I <sub>F</sub>	Forward current	(Note1)	200	A
I <sub>FRM</sub>		Pulse, Repetitive (Note2)	400	

**MODULE**

Symbol	Item	Conditions	Rating	Unit
V <sub>isol</sub>	Isolation voltage	Terminals to base plate, RMS, f=60 Hz, AC 1 min	4000	V
T <sub>jmax</sub>	Maximum junction temperature	Instantaneous event (overload)	175	°C
T <sub>Cmax</sub>	Maximum case temperature	(Note3)	125	
T <sub>jop</sub>	Operating junction temperature	Continuous operation (under switching)	-40 ~ +150	°C
T <sub>stg</sub>	Storage temperature	-	-40 ~ +125	

**ELECTRICAL CHARACTERISTICS (T<sub>j</sub>=25 °C, unless otherwise specified)**

**IGBT**

Symbol	Item	Conditions	Limits			Unit	
			Min.	Typ.	Max.		
I <sub>CES</sub>	Collector-emitter cut-off current	V <sub>CE</sub> =V <sub>CES</sub> , G-E short-circuited	-	-	1.0	mA	
I <sub>GES</sub>	Gate-emitter leakage current	V <sub>GE</sub> =V <sub>GES</sub> , C-E short-circuited	-	-	0.5	µA	
V <sub>GE(th)</sub>	Gate-emitter threshold voltage	I <sub>C</sub> =20 mA, V <sub>CE</sub> =10 V	5.4	6.0	6.6	V	
V <sub>CEsat</sub>	Collector-emitter saturation voltage	I <sub>C</sub> =200 A (Note4), V <sub>GE</sub> =15 V, (Terminal)	T <sub>j</sub> =25 °C	-	1.80	2.25	V
			T <sub>j</sub> =125 °C	-	2.00	-	
			T <sub>j</sub> =150 °C	-	2.05	-	
		I <sub>C</sub> =200 A (Note4), V <sub>GE</sub> =15 V, (Chip)	T <sub>j</sub> =25 °C	-	1.70	2.15	V
			T <sub>j</sub> =125 °C	-	1.90	-	
			T <sub>j</sub> =150 °C	-	1.95	-	
C <sub>ies</sub>	Input capacitance	V <sub>CE</sub> =10 V, G-E short-circuited	-	-	20	nF	
C <sub>oes</sub>	Output capacitance		-	-	4.0		
C <sub>res</sub>	Reverse transfer capacitance		-	-	0.33		
Q <sub>G</sub>	Gate charge	V <sub>CC</sub> =600 V, I <sub>C</sub> =200 A, V <sub>GE</sub> =15 V	-	466	-	nC	
t <sub>d(on)</sub>	Turn-on delay time	V <sub>CC</sub> =600 V, I <sub>C</sub> =200 A, V <sub>GE</sub> =±15 V, R <sub>G</sub> =0 Ω, Inductive load	-	-	800	ns	
t <sub>r</sub>	Rise time		-	-	200		
t <sub>d(off)</sub>	Turn-off delay time		-	-	600		
t <sub>f</sub>	Fall time		-	-	300		
E <sub>on</sub>	Turn-on switching energy per pulse	V <sub>CC</sub> =600 V, I <sub>F</sub> =200 A, V <sub>GE</sub> =±15 V, R <sub>G</sub> =0 Ω, T <sub>j</sub> =150 °C, Inductive load	-	30.7	-	mJ	
E <sub>off</sub>	Turn-off switching energy per pulse	-	-	21.5	-		
R <sub>CC'+EE'</sub>	Internal lead resistance	Main terminals-chip, per element, T <sub>C</sub> =25 °C (Note3)	-	-	2.0	mΩ	
r <sub>g</sub>	Internal gate resistance	-	-	9.8	-	Ω	

< IGBT MODULES >

CM200EXS-24S

HIGH POWER SWITCHING USE  
INSULATED TYPE

ELECTRICAL CHARACTERISTICS (cont; T<sub>j</sub>=25 °C, unless otherwise specified)

DIODE

Symbol	Item	Conditions	Limits			Unit	
			Min.	Typ.	Max.		
I <sub>RRM</sub>	Reverse current	V <sub>R</sub> =V <sub>RRM</sub>	-	-	1.0	mA	
V <sub>F</sub>	Forward voltage	I <sub>F</sub> =200 A <sup>(Note4)</sup> , (Terminal)	T <sub>j</sub> =25 °C	-	1.8	2.25	V
			T <sub>j</sub> =125 °C	-	1.8	-	
			T <sub>j</sub> =150 °C	-	1.8	-	
		I <sub>F</sub> =200 A <sup>(Note4)</sup> , (Chip)	T <sub>j</sub> =25 °C	-	1.7	2.15	V
			T <sub>j</sub> =125 °C	-	1.7	-	
			T <sub>j</sub> =150 °C	-	1.7	-	
t <sub>rr</sub>	Reverse recovery time	V <sub>CC</sub> =600 V, I <sub>F</sub> =200 A, V <sub>GE</sub> =±15 V,	-	-	300	ns	
Q <sub>rr</sub>	Reverse recovery charge	R <sub>G</sub> =0 Ω, Inductive load	-	10.7	-	μC	
E <sub>rr</sub>	Reverse recovery energy per pulse	V <sub>CC</sub> =600 V, I <sub>F</sub> =200 A, V <sub>GE</sub> =±15 V, R <sub>G</sub> =0 Ω, T <sub>j</sub> =150 °C, Inductive load	-	14.2	-	mJ	

NTC THERMISTOR

Symbol	Item	Conditions	Limits			Unit
			Min.	Typ.	Max.	
R <sub>25</sub>	Zero-power resistance	T <sub>C</sub> =25 °C <sup>(Note3)</sup>	4.85	5.00	5.15	kΩ
ΔR/R	Deviation of resistance	R <sub>100</sub> =493 Ω, T <sub>C</sub> =100 °C <sup>(Note3)</sup>	-7.3	-	+7.8	%
B <sub>(25/50)</sub>	B-constant	Approximate by equation <sup>(Note5)</sup>	-	3375	-	K
P <sub>25</sub>	Power dissipation	T <sub>C</sub> =25 °C <sup>(Note3)</sup>	-	-	10	mW

THERMAL RESISTANCE CHARACTERISTICS

Symbol	Item	Conditions	Limits			Unit
			Min.	Typ.	Max.	
R <sub>th(j-c)Q</sub>	Thermal resistance	Junction to case, IGBT <sup>(ote3)</sup>	-	-	0.10	K/W
R <sub>th(j-c)D</sub>		Junction to case, DIODE <sup>(Note3)</sup>	-	-	0.19	
R <sub>th(c-s)</sub>	Contact thermal resistance	Case to heat sink, per 1 module, Thermal grease applied <sup>(Note3, 6)</sup>	-	25	-	K/kW

MECHANICAL CHARACTERISTICS

Symbol	Item	Conditions	Limits			Unit
			Min.	Typ.	Max.	
M <sub>t</sub>	Mounting torque	Main terminals M 5 screw	2.5	3.0	3.5	N·m
M <sub>s</sub>	Mounting torque	Mounting to heat sink M 5 screw	2.5	3.0	3.5	N·m
d <sub>s</sub>	Creepage distance	Terminal to terminal	20.6	-	-	mm
		Terminal to base plate	17	-	-	
d <sub>a</sub>	Clearance	Terminal to terminal	12	-	-	mm
		Terminal to base plate	10.6	-	-	
m	Weight	-	-	210	-	g
e <sub>c</sub>	Flatness of base plate	On the centerline X, Y <sup>(Note7)</sup>	-100	-	+100	μm

< IGBT MODULES >  
**CM200EXS-24S**  
**HIGH POWER SWITCHING USE**  
**INSULATED TYPE**

Note1. Junction temperature ( $T_j$ ) should not increase beyond  $T_{jmax}$  rating.

2. Pulse width and repetition rate should be such that the device junction temperature ( $T_j$ ) dose not exceed  $T_{jmax}$  rating.
3. Case temperature ( $T_c$ ) and heat sink temperature ( $T_s$ ) are defined on the each surface (mounting side) of base plate and heat sink just under the chips. Refer to the figure of chip location.

4. Pulse width and repetition rate should be such as to cause negligible temperature rise.  
 Refer to the figure of test circuit.

$$5. B_{(25/50)} = \ln\left(\frac{R_{25}}{R_{50}}\right) / \left(\frac{1}{T_{25}} - \frac{1}{T_{50}}\right),$$

$R_{25}$ : resistance at absolute temperature  $T_{25}$  [K];  $T_{25}=25 [^{\circ}\text{C}]+273.15=298.15$  [K]

$R_{50}$ : resistance at absolute temperature  $T_{50}$  [K];  $T_{50}=50 [^{\circ}\text{C}]+273.15=323.15$  [K]

6. Typical value is measured by using thermally conductive grease of  $\lambda=0.9$  W/(m·K).

7. The base plate (mounting side) flatness measurement points (X, Y) are as follows of the following figure.

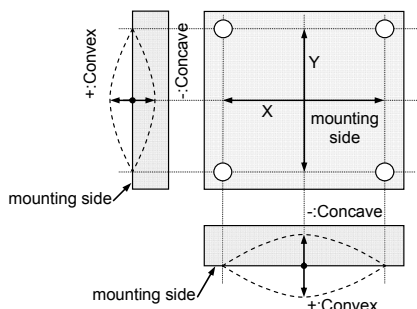

8. Use the following screws when mounting the printed circuit board (PCB) on the stand offs.

" $\varnothing 2.6 \times 10$  or  $\varnothing 2.6 \times 12$  self tapping screw"

The length of the screw depends on thickness (t1.6~t2.0) of the PCB.

**RECOMMENDED OPERATING CONDITIONS**

Symbol	Item	Conditions	Limits			Unit
			Min.	Typ.	Max.	
$V_{CC}$	(DC) Supply voltage	Applied across C-E/A-K terminals	-	600	850	V
$V_{GEon}$	Gate (-emitter drive) voltage	Applied across G-Es terminals	13.5	15.0	16.5	V
$R_G$	External gate resistance	-	0	-	22	$\Omega$

**CHIP LOCATION (Top view)**

Dimension in mm, tolerance:  $\pm 1$  mm

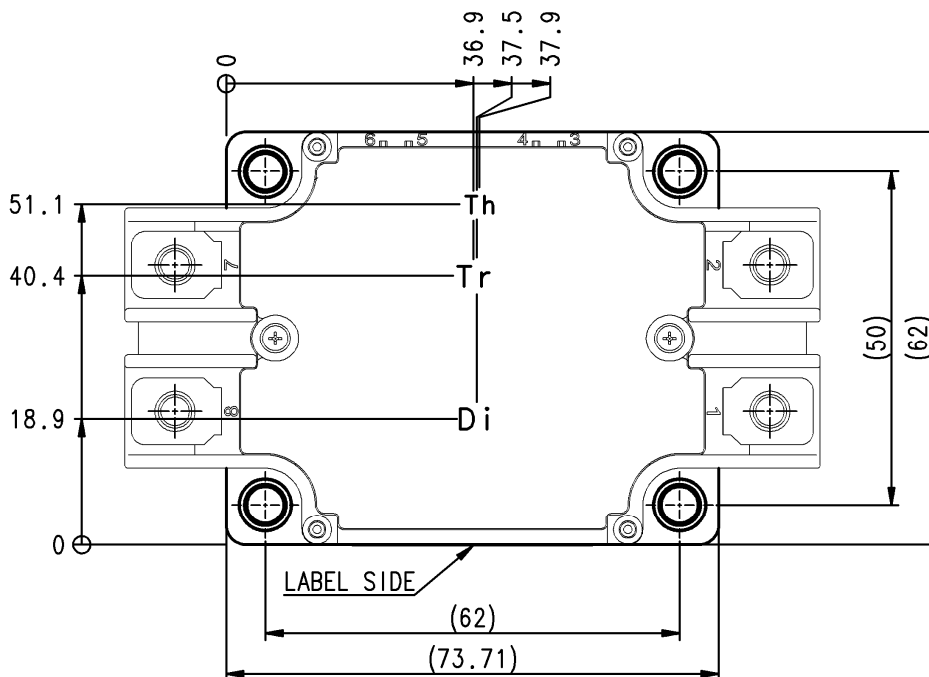

Tr: IGBT, Di: CLAMP DIODE, Th: NTC thermistor

< IGBT MODULES >  
**CM200EXS-24S**  
 HIGH POWER SWITCHING USE  
 INSULATED TYPE

**TEST CIRCUIT AND WAVEFORMS**

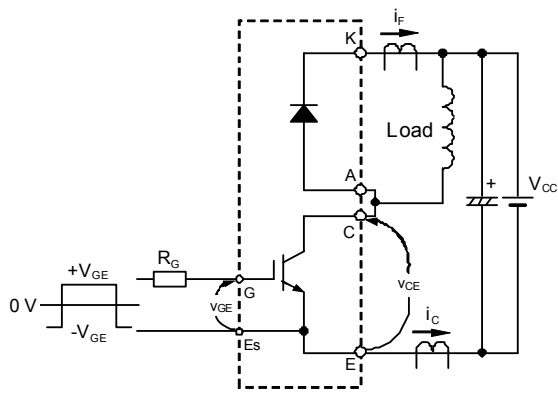

**Switching characteristics test circuit and waveforms**

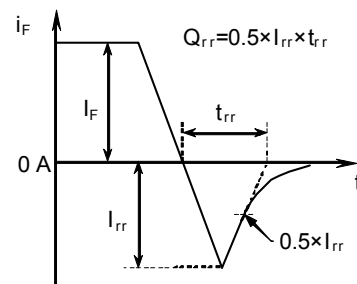
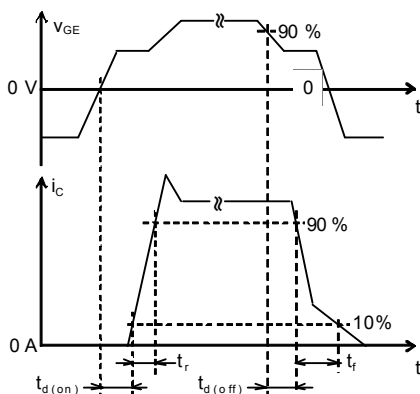

**$t_{rr}$ ,  $Q_{rr}$  test waveform**

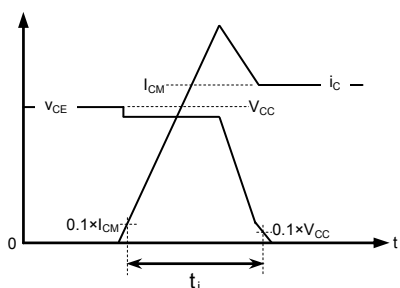

**IGBT Turn-on switching energy**

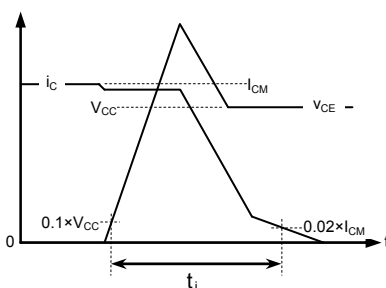

**IGBT Turn-off switching energy**

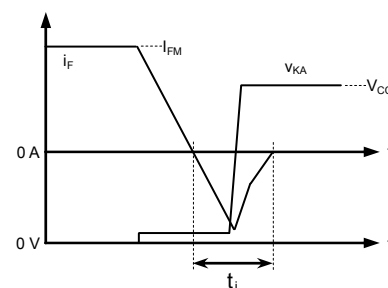

**DIODE Reverse recovery energy**

**Turn-on / Turn-off switching energy and Reverse recovery energy test waveforms (Integral time instruction drawing)**

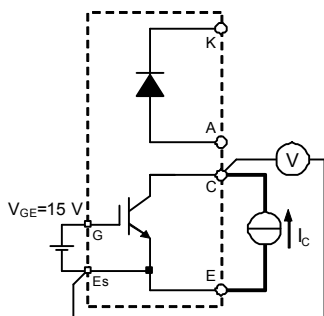

**$V_{CEsat}$  test circuit**

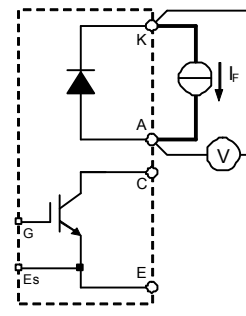

**$V_F$  test circuit**

< IGBT MODULES >  
**CM200EXS-24S**  
 HIGH POWER SWITCHING USE  
 INSULATED TYPE

PERFORMANCE CURVES

IGBT/DIODE

OUTPUT CHARACTERISTICS  
 (TYPICAL)

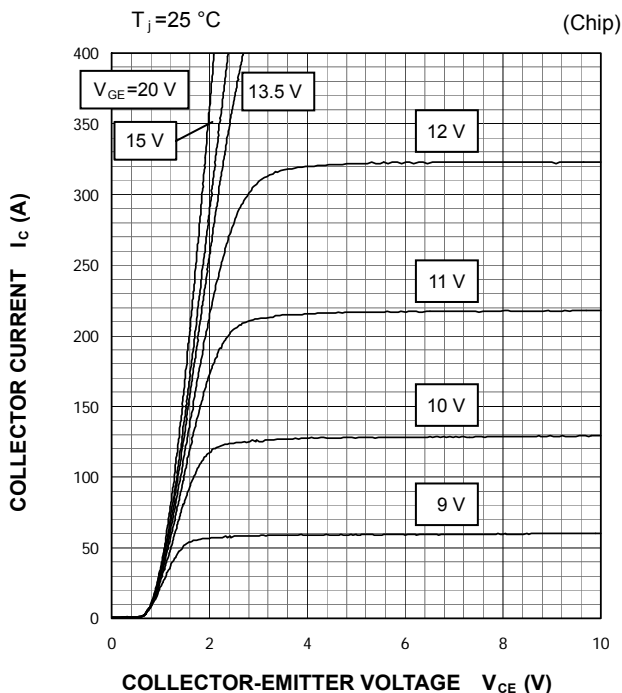

COLLECTOR-EMITTER SATURATION VOLTAGE  
 CHARACTERISTICS  
 (TYPICAL)

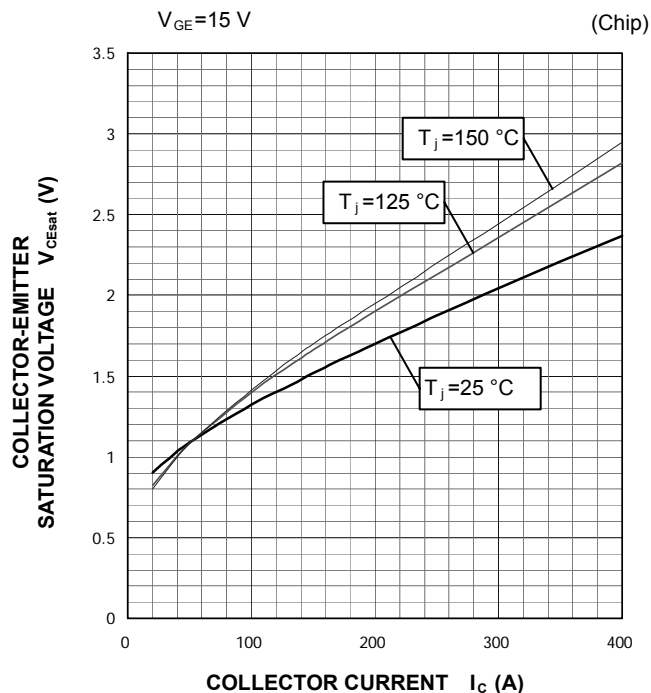

COLLECTOR-EMITTER SATURATION VOLTAGE  
 CHARACTERISTICS  
 (TYPICAL)

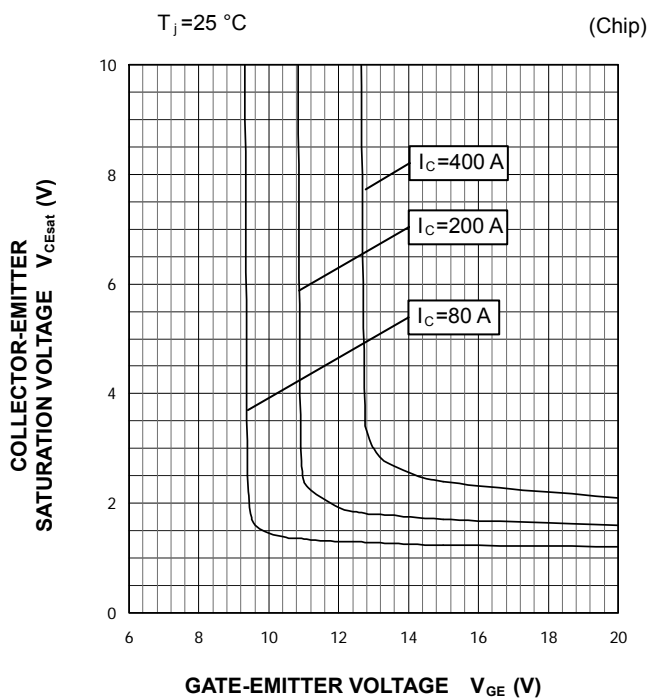

DIODE  
 FORWARD CHARACTERISTICS  
 (TYPICAL)

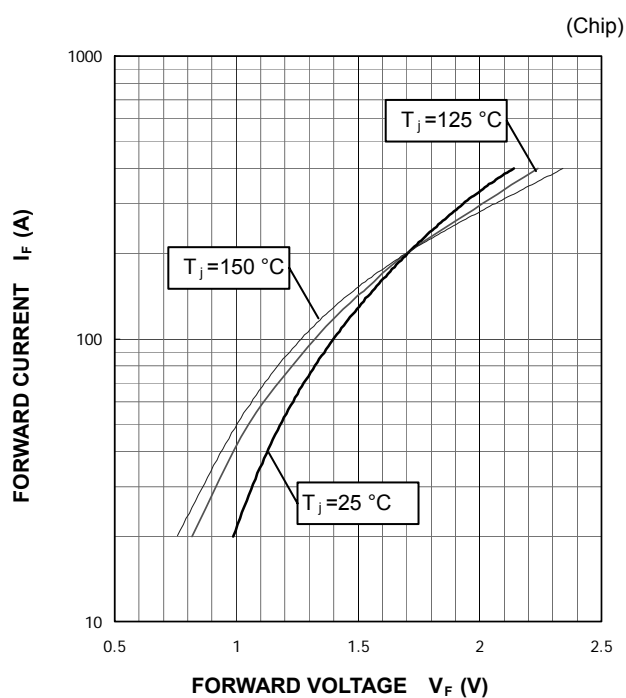

PERFORMANCE CURVES

IGBT/DIODE

HALF-BRIDGE  
SWITCHING CHARACTERISTICS  
(TYPICAL)

$V_{CC}=600\text{ V}$ ,  $V_{GE}=\pm 15\text{ V}$ ,  $R_G=0\ \Omega$ , INDUCTIVE LOAD  
——:  $T_j=150\text{ }^\circ\text{C}$ , - - - -:  $T_j=125\text{ }^\circ\text{C}$

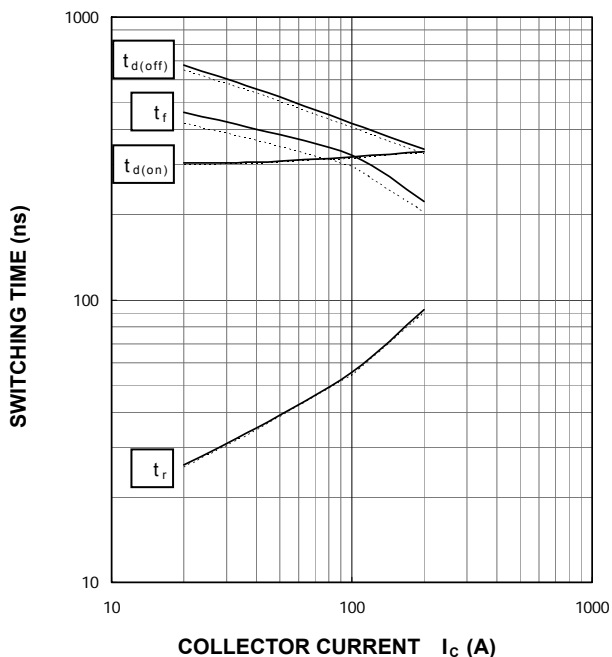

HALF-BRIDGE  
SWITCHING CHARACTERISTICS  
(TYPICAL)

$V_{CC}=600\text{ V}$ ,  $V_{GE}=\pm 15\text{ V}$ ,  $I_C=200\text{ A}$ , INDUCTIVE LOAD  
——:  $T_j=150\text{ }^\circ\text{C}$ , - - - -:  $T_j=125\text{ }^\circ\text{C}$

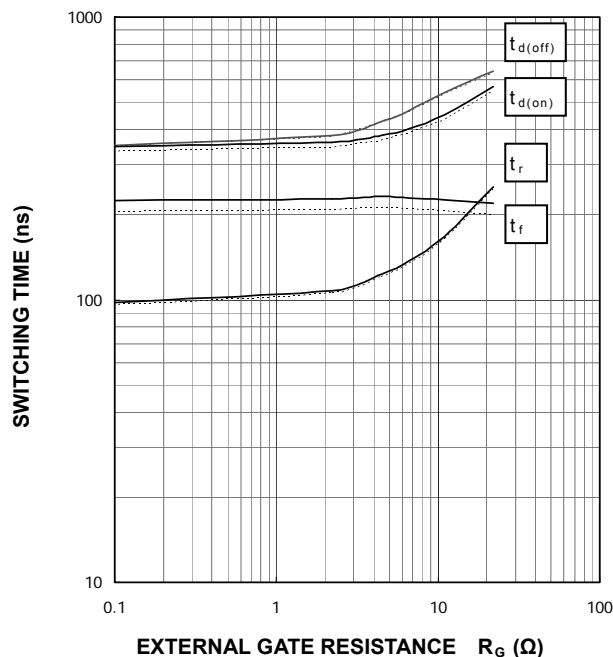

HALF-BRIDGE  
SWITCHING CHARACTERISTICS  
(TYPICAL)

$V_{CC}=600\text{ V}$ ,  $V_{GE}=\pm 15\text{ V}$ ,  $R_G=0\ \Omega$ ,  
INDUCTIVE LOAD, PER PULSE  
——:  $T_j=150\text{ }^\circ\text{C}$ , - - - -:  $T_j=125\text{ }^\circ\text{C}$

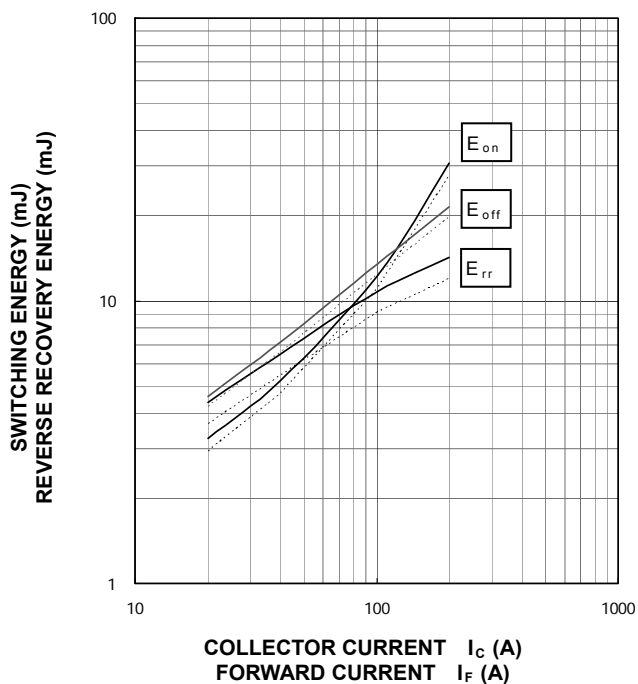

HALF-BRIDGE  
SWITCHING CHARACTERISTICS  
(TYPICAL)

$V_{CC}=600\text{ V}$ ,  $V_{GE}=\pm 15\text{ V}$ ,  $I_C/I_F=200\text{ A}$ ,  
INDUCTIVE LOAD, PER PULSE  
——:  $T_j=150\text{ }^\circ\text{C}$ , - - - -:  $T_j=125\text{ }^\circ\text{C}$

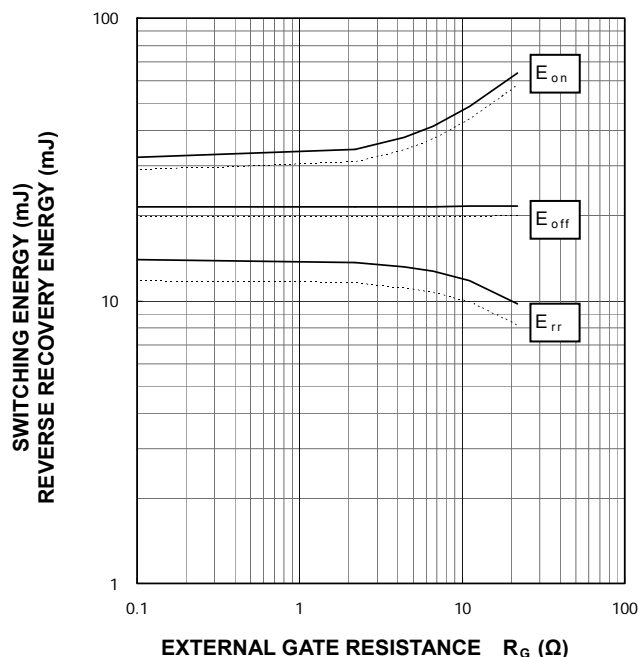

< IGBT MODULES >  
**CM200EXS-24S**  
 HIGH POWER SWITCHING USE  
 INSULATED TYPE

PERFORMANCE CURVES

IGBT/DIODE

**CAPACITANCE CHARACTERISTICS (TYPICAL)**

G-E short-circuited,  $T_j=25\text{ }^\circ\text{C}$

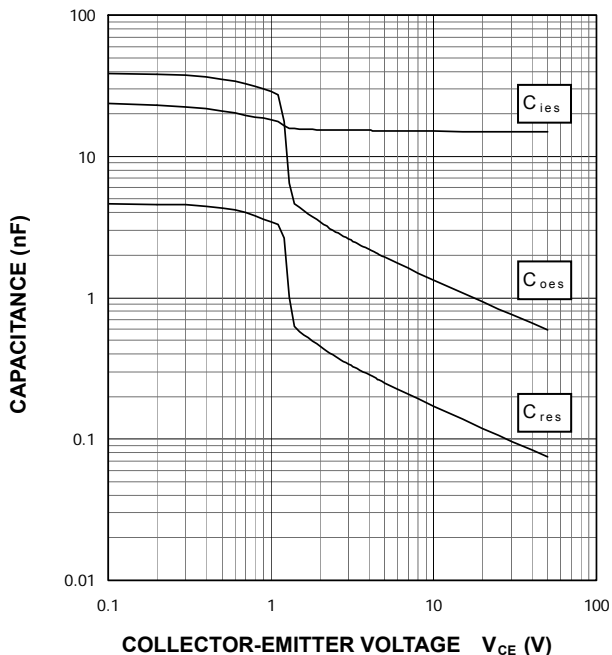

**DIODE REVERSE RECOVERY CHARACTERISTICS (TYPICAL)**

$V_{CC}=600\text{ V}$ ,  $V_{GE}=\pm 15\text{ V}$ ,  $R_G=0\ \Omega$ , INDUCTIVE LOAD  
 —:  $T_j=150\text{ }^\circ\text{C}$ , - - - -:  $T_j=125\text{ }^\circ\text{C}$

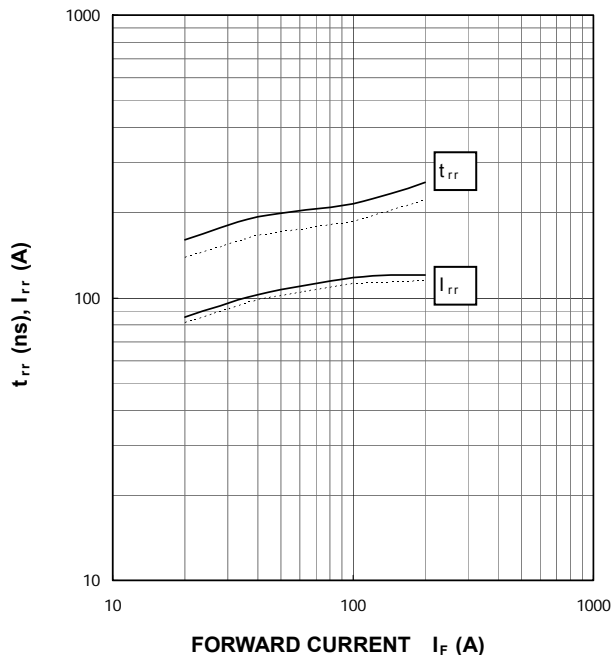

**GATE CHARGE CHARACTERISTICS (TYPICAL)**

$V_{CC}=600\text{ V}$ ,  $I_C=200\text{ A}$ ,  $T_j=25\text{ }^\circ\text{C}$

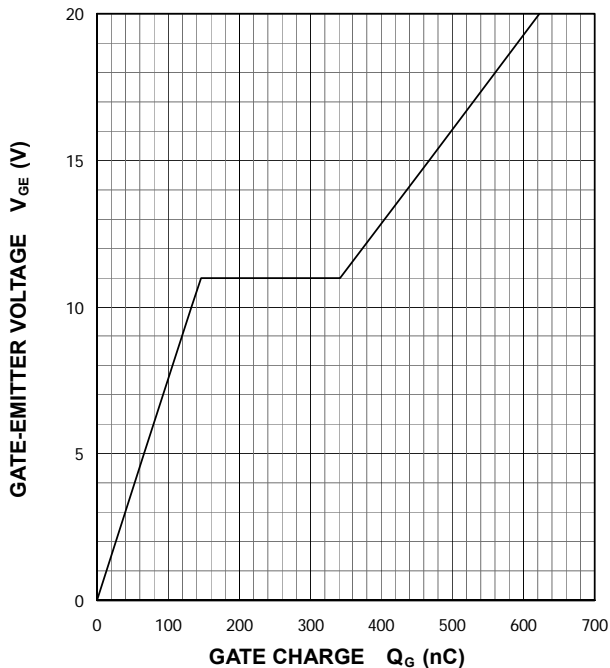

**TRANSIENT THERMAL IMPEDANCE CHARACTERISTICS (MAXIMUM)**

Single pulse,  $T_C=25\text{ }^\circ\text{C}$   
 $R_{th(j-c)Q}=0.10\text{ K/W}$ ,  $R_{th(j-c)D}=0.19\text{ K/W}$

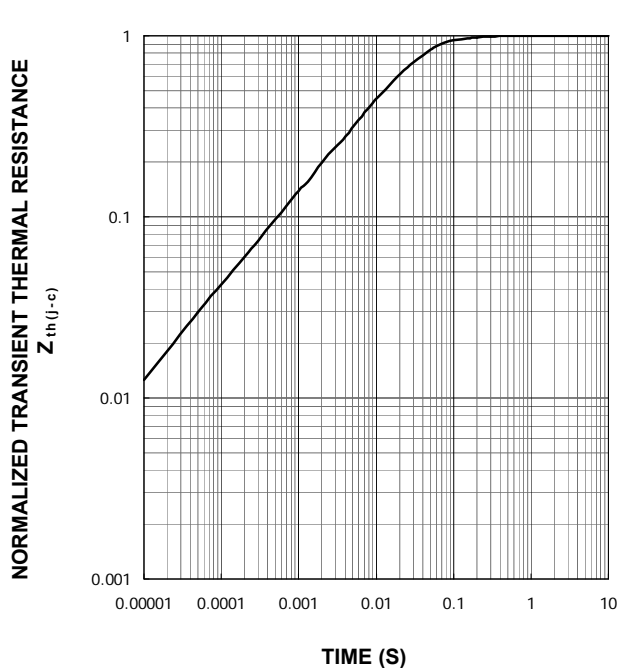



< IGBT MODULES >  
CM200EXS-24S  
HIGH POWER SWITCHING USE  
INSULATED TYPE

---

PERFORMANCE CURVES

NTC THERMISTOR

TEMPERATURE CHARACTERISTICS  
(TYPICAL)

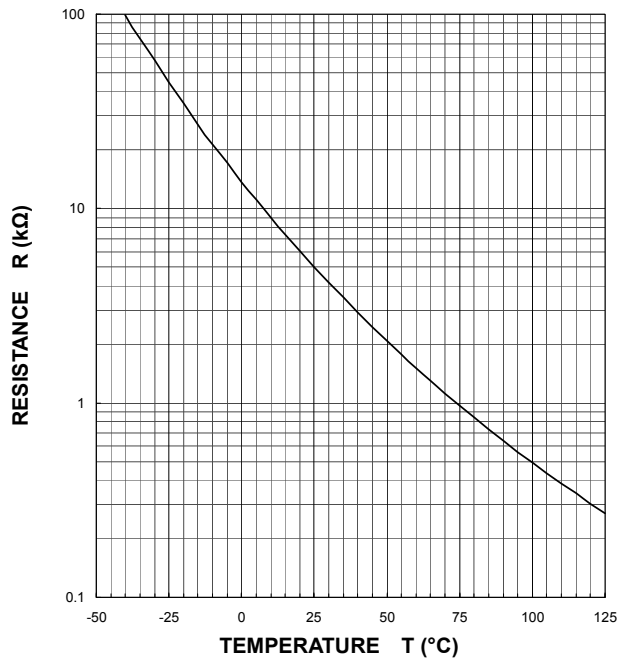

### **Keep safety first in your circuit designs!**

Mitsubishi Electric Corporation puts the maximum effort into making semiconductor products better and more reliable, but there is always the possibility that trouble may occur with them. Trouble with semiconductors may lead to personal injury, fire or property damage. Remember to give due consideration to safety when making your circuit designs, with appropriate measures such as (i) placement of substitutive, auxiliary circuits, (ii) use of non-flammable material or (iii) prevention against any malfunction or mishap.

### **Notes regarding these materials**

- These materials are intended as a reference to assist our customers in the selection of the Mitsubishi semiconductor product best suited to the customer's application; they do not convey any license under any intellectual property rights, or any other rights, belonging to Mitsubishi Electric Corporation or a third party.
- Mitsubishi Electric Corporation assumes no responsibility for any damage, or infringement of any third-party's rights, originating in the use of any product data, diagrams, charts, programs, algorithms, or circuit application examples contained in these materials.
- All information contained in these materials, including product data, diagrams, charts, programs and algorithms represents information on products at the time of publication of these materials, and are subject to change by Mitsubishi Electric Corporation without notice due to product improvements or other reasons. It is therefore recommended that customers contact Mitsubishi Electric Corporation or an authorized Mitsubishi Semiconductor product distributor for the latest product information before purchasing a product listed herein.  
The information described here may contain technical inaccuracies or typographical errors. Mitsubishi Electric Corporation assumes no responsibility for any damage, liability, or other loss rising from these inaccuracies or errors.  
Please also pay attention to information published by Mitsubishi Electric Corporation by various means, including the Mitsubishi Semiconductor home page ([www.MitsubishiElectric.com/semiconductors/](http://www.MitsubishiElectric.com/semiconductors/)).
- When using any or all of the information contained in these materials, including product data, diagrams, charts, programs, and algorithms, please be sure to evaluate all information as a total system before making a final decision on the applicability of the information and products. Mitsubishi Electric Corporation assumes no responsibility for any damage, liability or other loss resulting from the information contained herein.
- Mitsubishi Electric Corporation semiconductors are not designed or manufactured for use in a device or system that is used under circumstances in which human life is potentially at stake. Please contact Mitsubishi Electric Corporation or an authorized Mitsubishi Semiconductor product distributor when considering the use of a product contained herein for any specific purposes, such as apparatus or systems for transportation, vehicular, medical, aerospace, nuclear, or undersea repeater use.
- The prior written approval of Mitsubishi Electric Corporation is necessary to reprint or reproduce in whole or in part these materials.
- If these products or technologies are subject to the Japanese export control restrictions, they must be exported under a license from the Japanese government and cannot be imported into a country other than the approved destination.  
Any diversion or reexport contrary to the export control laws and regulations of Japan and/or the country of destination is prohibited.
- Please contact Mitsubishi Electric Corporation or an authorized Mitsubishi Semiconductor product distributor for further details on these materials or the products contained therein.