

MITSUBISHI HVIGBT MODULES
CM2400HC-34N

4th-Version HVIGBT (High Voltage Insulated Gate Bipolar Transistor) Modules

HIGH POWER SWITCHING USE
 INSULATED TYPE

CM2400HC-34N



- Ic 2400A
- VCES 1700V
- Insulated Type
- 1-element in a Pack
- AlSiC Baseplate
- Trench Gate IGBT : CSTBT™
- Soft Reverse Recovery Diode

APPLICATION

Traction drives, High Reliability Converters / Inverters, DC choppers

OUTLINE DRAWING & CIRCUIT DIAGRAM

Dimensions in mm

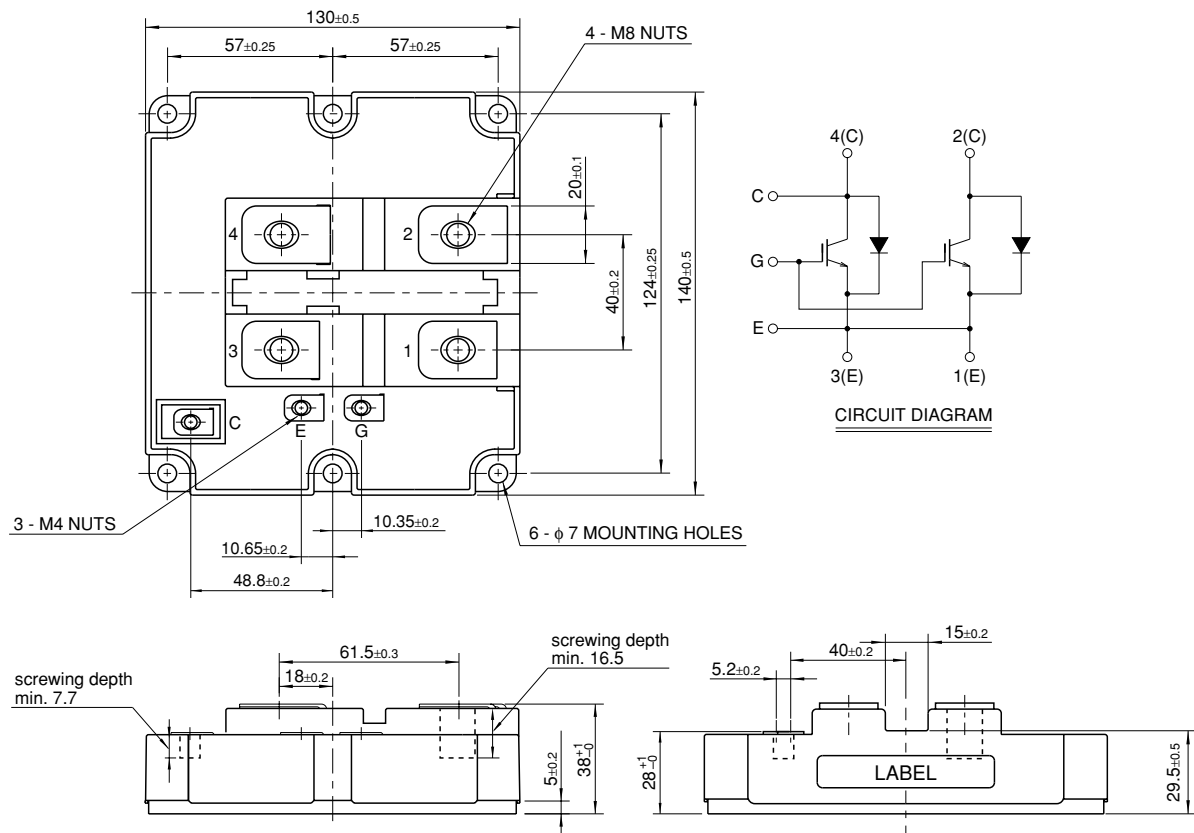

HVIGBT (High Voltage Insulated Gate Bipolar Transistor) Modules

Jul. 2005

CM2400HC-34N

**HIGH POWER SWITCHING USE
INSULATED TYPE**

4th-Version HVIGBT (High Voltage Insulated Gate Bipolar Transistor) Modules

MAXIMUM RATINGS

| Symbol | Item | Conditions | Ratings | Unit |
|--------------------------|-----------------------------------|---|------------|------|
| V _{CE} S | Collector-emitter voltage | V _{GE} = 0V, T _j = 25°C | 1700 | V |
| V _{GE} S | Gate-emitter voltage | V _{CE} = 0V, T _j = 25°C | ±20 | V |
| I _C | Collector current | T _C = 75°C | 2400 | A |
| I _{CM} | | Pulse (Note 1) | 4800 | A |
| I _E (Note 2) | Emitter current | | 2400 | A |
| I _{EM} (Note 2) | | Pulse (Note 1) | 4800 | A |
| P _C (Note 3) | Maximum power dissipation | T _C = 25°C, IGBT part | 13100 | W |
| T _j | Junction temperature | | -40 ~ +150 | °C |
| T _{op} | Operating temperature | | -40 ~ +125 | °C |
| T _{stg} | Storage temperature | | -40 ~ +125 | °C |
| V _{iso} | Isolation voltage | RMS, sinusoidal, f = 60Hz, t = 1min. | 4000 | V |
| t _p sc | Maximum short circuit pulse width | V _{CC} = 1200V, V _{CE} ≤ 1700V, V _{GE} = 15V T _j = 125°C | 10 | μs |

ELECTRICAL CHARACTERISTICS

| Symbol | Item | Conditions | Limits | | | Unit |
|---------------------------|--------------------------------------|--|--|------|------|----------|
| | | | Min | Typ | Max | |
| I _{CES} | Collector cut-off current | V _{CE} = V _{CE} S, V _{GE} = 0V, T _j = 25°C | — | — | 8 | mA |
| V _{GE(th)} | Gate-emitter threshold voltage | I _C = 240mA, V _{CE} = 10V, T _j = 25°C | 6.0 | 7.0 | 8.0 | V |
| I _{GES} | Gate leakage current | V _{GE} = V _{GES} , V _{CE} = 0V, T _j = 25°C | — | — | 0.5 | μA |
| V _{CE(sat)} | Collector-emitter saturation voltage | I _C = 2400A, V _{GE} = 15V, T _j = 25°C (Note 4) | — | 2.15 | 2.80 | V |
| | | I _C = 2400A, V _{GE} = 15V, T _j = 125°C (Note 4) | — | 2.40 | — | |
| C _{ies} | Input capacitance | V _{CE} = 10V, f = 100kHz V _{GE} = 0V, T _j = 25°C | — | 352 | — | nF |
| C _{oes} | Output capacitance | | — | 19.2 | — | nF |
| C _{res} | Reverse transfer capacitance | | — | 5.6 | — | nF |
| Q _g | Total gate charge | V _{CC} = 850V, I _C = 2400A, V _{GE} = 15V, T _j = 25°C | — | 13.6 | — | μC |
| V _{EC} (Note 2) | Emitter-collector voltage | I _E = 2400A, V _{GE} = 0V, T _j = 25°C (Note 4) | — | 2.60 | 3.30 | V |
| | | I _E = 2400A, V _{GE} = 0V, T _j = 125°C (Note 4) | — | 2.30 | — | |
| t _{d(on)} | Turn-on delay time | V _{CC} = 850V, I _C = 2400A, V _{GE} = ±15V Inductive load | — | 1.00 | — | μs |
| t _r | Turn-on rise time | | RG(on) = 0.7Ω, T _j = 125°C, L _s = 100nH | — | 0.40 | — |
| E _{on} | Turn-on switching energy | Inductive load | — | 640 | — | mJ/pulse |
| t _{d(off)} | Turn-off delay time | V _{CC} = 850V, I _C = 2400A, V _{GE} = ±15V Inductive load | — | 1.20 | — | μs |
| t _f | Turn-off fall time | | RG(off) = 1.6Ω, T _j = 125°C, L _s = 100nH | — | 0.30 | — |
| E _{off} | Turn-off switching energy | Inductive load | — | 840 | — | mJ/pulse |
| t _{rr} (Note 2) | Reverse recovery time | V _{CC} = 850V, I _C = 2400A, V _{GE} = ±15V | — | 1.00 | — | μs |
| I _{rr} (Note 2) | Reverse recovery current | RG(on) = 0.7Ω, T _j = 125°C, L _s = 100nH Inductive load | — | 900 | — | A |
| Q _{rr} (Note 2) | Reverse recovery charge | | — | 620 | — | μC |
| E _{rec} (Note 2) | Reverse recovery energy | Inductive load | — | 380 | — | mJ/pulse |

- Note 1. Pulse width and repetition rate should be such that junction temperature (T_j) does not exceed T_{op}max rating (125°C).
 2. The symbols represent characteristics of the anti-parallel, emitter to collector free-wheel diode (FWDi).
 3. Junction temperature (T_j) should not exceed T_jmax rating (150°C).
 4. Pulse width and repetition rate should be such as to cause negligible temperature rise.

CM2400HC-34N

**HIGH POWER SWITCHING USE
INSULATED TYPE**

4th-Version HVIGBT (High Voltage Insulated Gate Bipolar Transistor) Modules

THERMAL CHARACTERISTICS

| Symbol | Item | Conditions | Limits | | | Unit |
|-----------------------|----------------------------|---|--------|-----|------|------|
| | | | Min | Typ | Max | |
| R _{th(j-c)Q} | Thermal resistance | Junction to Case, IGBT part | — | — | 9.5 | K/kW |
| R _{th(j-c)R} | | Junction to Case, FWDi part | — | — | 21.0 | K/kW |
| R _{th(c-f)} | Contact thermal resistance | Case to Fin, $\lambda_{grease} = 1W/m\cdot K$ | — | 8.0 | — | K/kW |

MECHANICAL CHARACTERISTICS

| Symbol | Item | Conditions | Limits | | | Unit |
|----------------|---------------------------------|--------------------------------|--------|------|------|------|
| | | | Min | Typ | Max | |
| M | Mounting torque | M8 : Main terminals screw | 7.0 | — | 20.0 | N·m |
| | | M6 : Mounting screw | 3.0 | — | 6.0 | |
| | | M4 : Auxiliary terminals screw | 1.0 | — | 3.0 | |
| — | Mass | | — | 0.8 | — | kg |
| CTI | Comparative tracking index | | 600 | — | — | — |
| d _a | Clearance distance in air | | 19.5 | — | — | mm |
| d _s | Creepage distance along surface | | 32.0 | — | — | mm |
| LC-E(int) | Internal inductance | IGBT part | — | 16 | — | nH |
| RC-E(int) | Internal lead resistance | T _C = 25°C | — | 0.14 | — | mΩ |

CM2400HC-34N

HIGH POWER SWITCHING USE
INSULATED TYPE

4th-Version HVIGBT (High Voltage Insulated Gate Bipolar Transistor) Modules

PERFORMANCE CURVES

OUTPUT CHARACTERISTICS (TYPICAL)

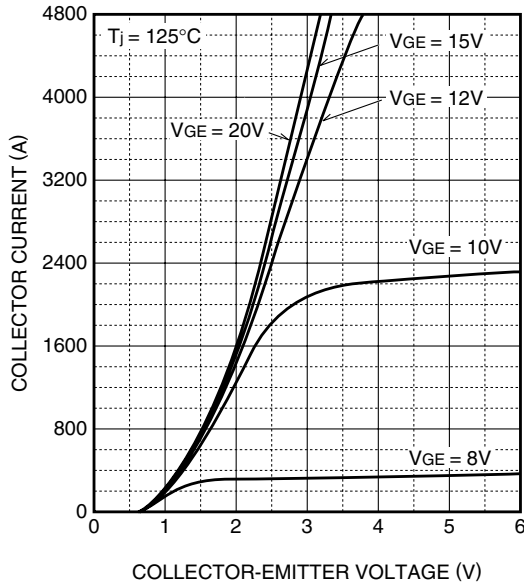

TRANSFER CHARACTERISTICS (TYPICAL)

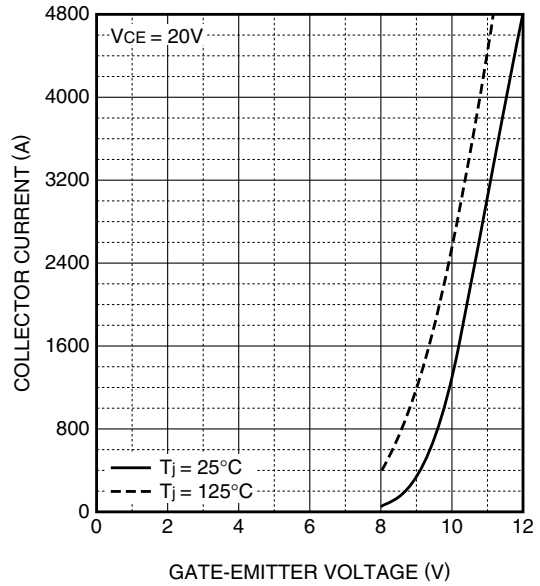

COLLECTOR-EMITTER SATURATION VOLTAGE CHARACTERISTICS (TYPICAL)

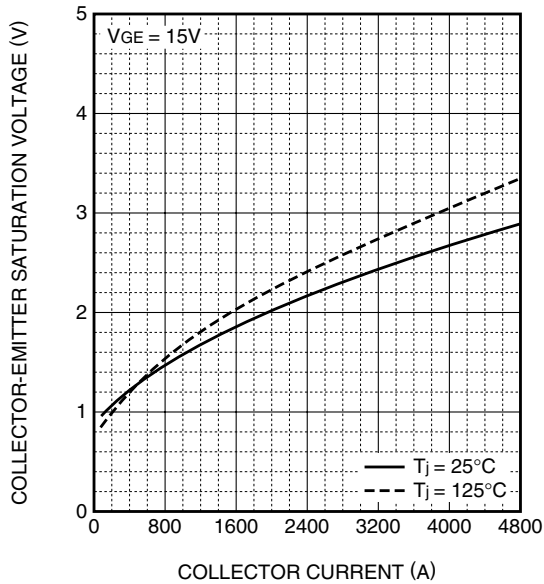

FREE-WHEEL DIODE FORWARD CHARACTERISTICS (TYPICAL)

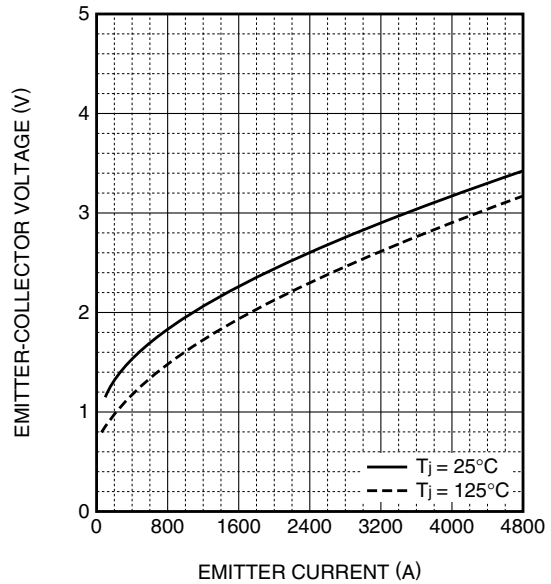

CM2400HC-34N

HIGH POWER SWITCHING USE
INSULATED TYPE

4th-Version HVIGBT (High Voltage Insulated Gate Bipolar Transistor) Modules

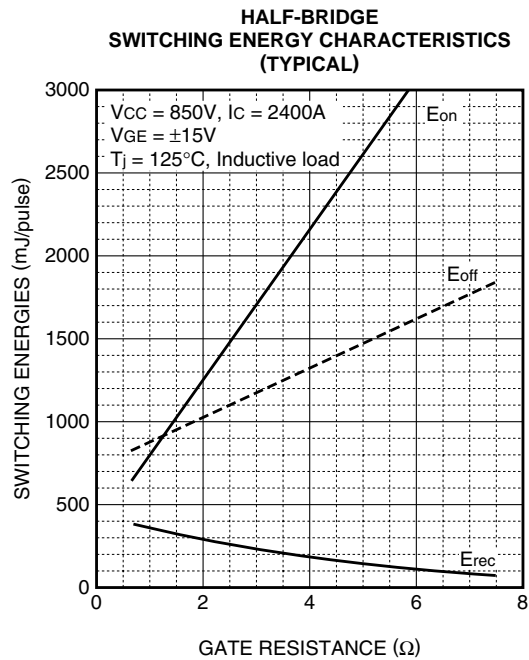
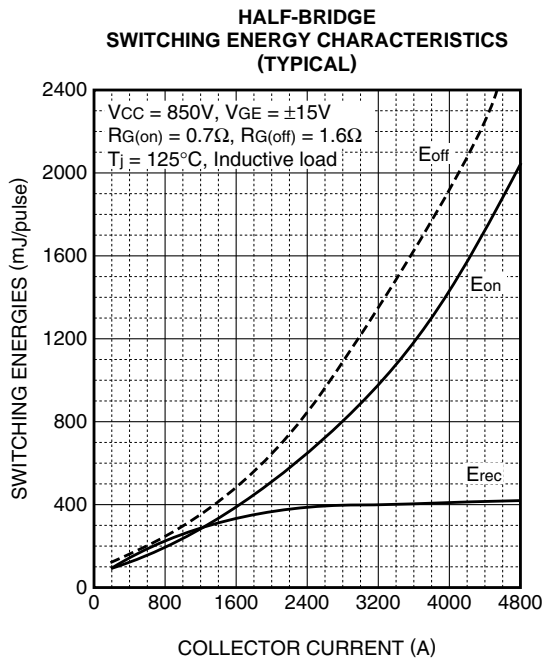
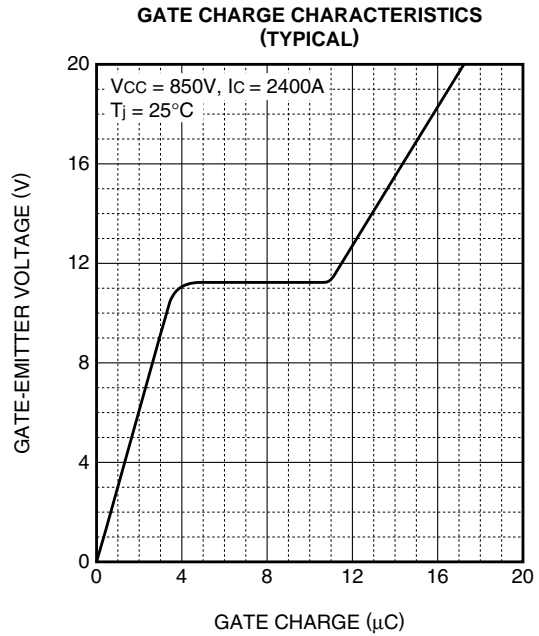
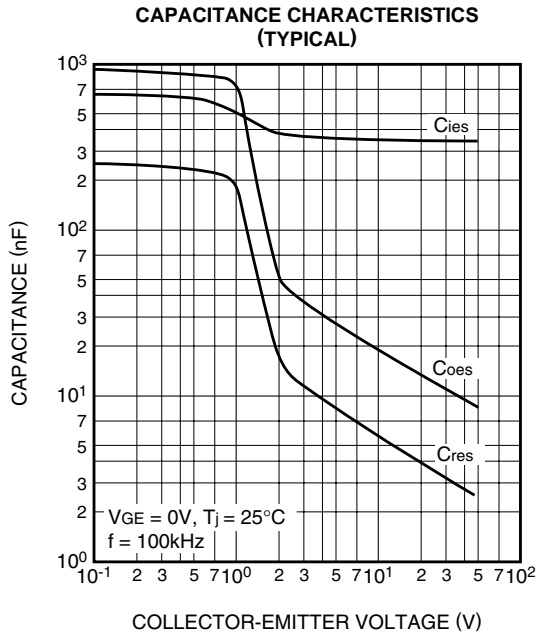

CM2400HC-34N

HIGH POWER SWITCHING USE
INSULATED TYPE

4th-Version HVIGBT (High Voltage Insulated Gate Bipolar Transistor) Modules

