

< IGBT MODULES >

# CM2500DY-24S

HIGH POWER SWITCHING USE  
INSULATED TYPE

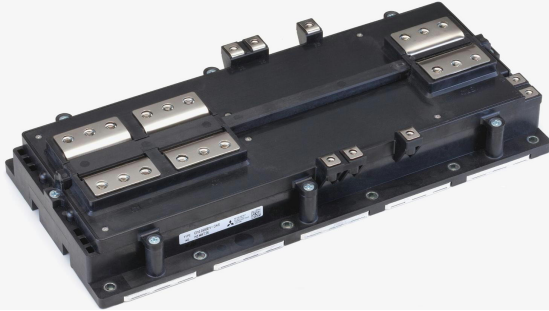

Dual switch (Half-Bridge)

Collector current  $I_C$  ..... **2 5 0 0 A**  
 Collector-emitter voltage  $V_{CES}$  ..... **1 2 0 0 V**  
 Maximum junction temperature  $T_{jmax}$  ..... **1 7 5 °C**

- Flat base Type
- Aluminum base plate
- RoHS Directive compliance
- Recognized under UL1557, File E323585

## APPLICATION

Wind power, Photovoltaic (Solar) power, AC Motor Control, Motion/Servo Control, Power supply, etc.

## OUTLINE DRAWING & INTERNAL CONNECTION

Dimension in mm

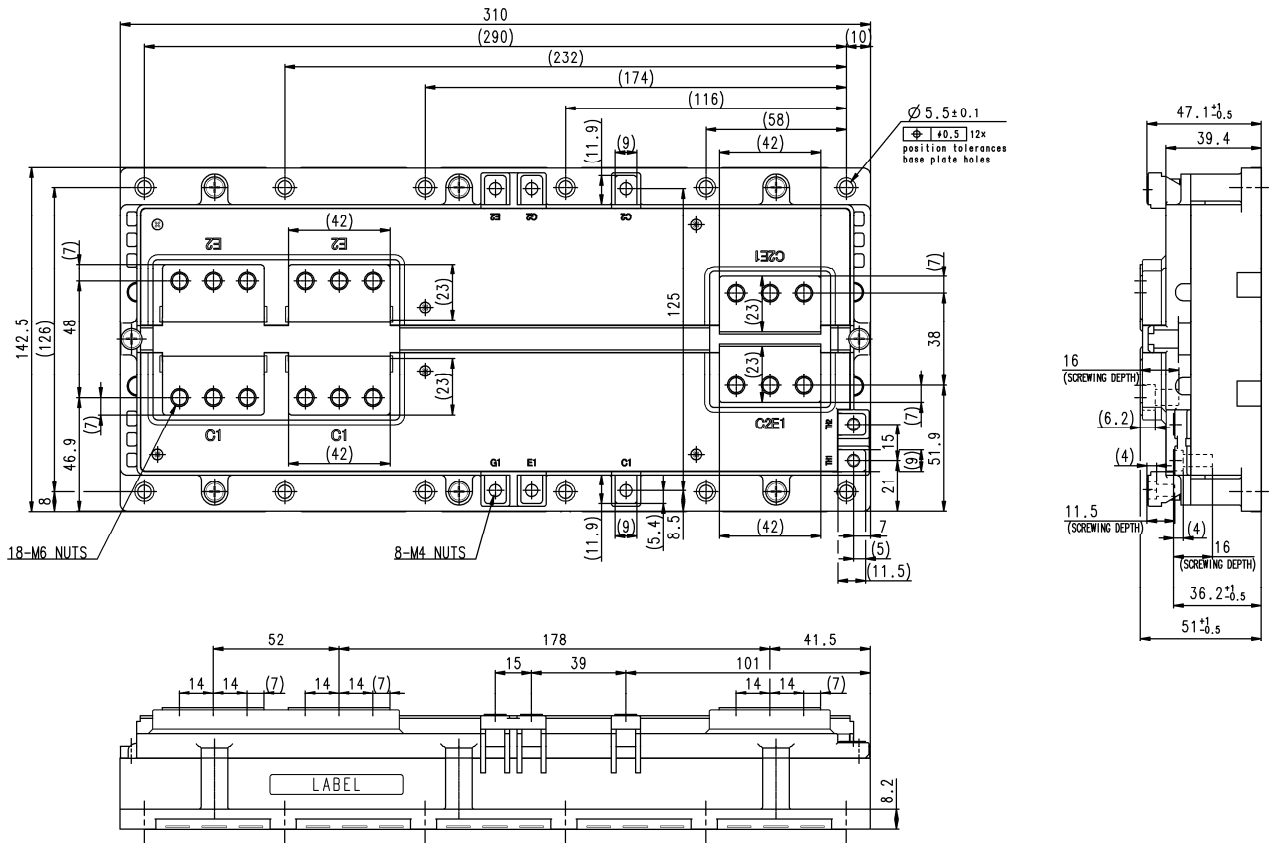

Tolerance otherwise specified

Division of Dimension	Tolerance
0.5 to 3	±0.2
over 3 to 6	±0.3
over 6 to 30	±0.5
over 30 to 120	±0.8
over 120 to 400	±1.2

### INTERNAL CONNECTION

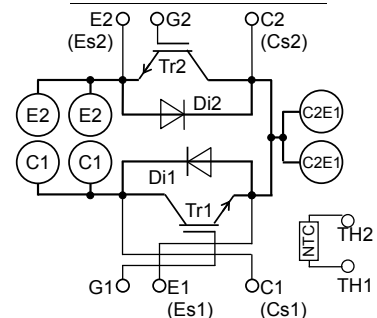

< IGBT MODULES >

CM2500DY-24S

HIGH POWER SWITCHING USE  
INSULATED TYPE

MAXIMUM RATINGS ( $T_j=25\text{ }^\circ\text{C}$ , unless otherwise specified)

INVERTER PART IGBT/DIODE

Symbol	Item	Conditions	Rating	Unit
$V_{CES}$	Collector-emitter voltage	G-E short-circuited	1200	V
$V_{GES}$	Gate-emitter voltage	C-E short-circuited	$\pm 20$	V
$I_C$	Collector current	DC, $T_C=84\text{ }^\circ\text{C}$ (Note2, 4)	2500	A
$I_{CRM}$		Pulse, Repetitive (Note3)	5000	
$P_{tot}$	Total power dissipation	$T_C=25\text{ }^\circ\text{C}$ (Note2, 4)	11535	W
$I_E$ (Note1)	Emitter current	DC (Note2)	2500	A
$I_{ERM}$ (Note1)		Pulse, Repetitive (Note3)	5000	

MODULE

Symbol	Item	Conditions	Rating	Unit
$V_{isol}$	Isolation voltage	Terminals to base plate, RMS, f=60 Hz, AC 1 min	4000	V
$T_{jmax}$	Maximum junction temperature	Instantaneous event (overload)	175	$^\circ\text{C}$
$T_{cmax}$	Maximum case temperature	(Note4)	125	
$T_{jopr}$	Operating junction temperature	Continuous operation (under switching)	-40 ~ +150	$^\circ\text{C}$
$T_{stg}$	Storage temperature	-	-40 ~ +125	

ELECTRICAL CHARACTERISTICS ( $T_j=25\text{ }^\circ\text{C}$ , unless otherwise specified)

INVERTER PART IGBT/DIODE

Symbol	Item	Conditions	Limits			Unit	
			Min.	Typ.	Max.		
$I_{CES}$	Collector-emitter cut-off current	$V_{CE}=V_{CES}$ , G-E short-circuited	-	-	1.0	mA	
$I_{GES}$	Gate-emitter leakage current	$V_{GE}=V_{GES}$ , C-E short-circuited	-	-	5.0	$\mu\text{A}$	
$V_{GE(th)}$	Gate-emitter threshold voltage	$I_C=250\text{ mA}$ , $V_{CE}=10\text{ V}$	5.4	6.0	6.6	V	
$V_{CESat}$ (Terminal)	Collector-emitter saturation voltage	$I_C=2500\text{ A}$ , $V_{GE}=15\text{ V}$ , Refer to the figure of test circuit (Note5)	$T_j=25\text{ }^\circ\text{C}$	-	1.80	2.25	V
			$T_j=125\text{ }^\circ\text{C}$	-	2.00	-	
			$T_j=150\text{ }^\circ\text{C}$	-	2.05	-	
$V_{CESat}$ (Chip)		$I_C=2500\text{ A}$ , $V_{GE}=15\text{ V}$ , (Note5)	$T_j=25\text{ }^\circ\text{C}$	-	1.70	2.15	V
			$T_j=125\text{ }^\circ\text{C}$	-	1.90	-	
			$T_j=150\text{ }^\circ\text{C}$	-	1.95	-	
$C_{ies}$	Input capacitance	$V_{CE}=10\text{ V}$ , G-E short-circuited	-	-	250	nF	
$C_{oes}$	Output capacitance		-	-	50		
$C_{res}$	Reverse transfer capacitance		-	-	4.2		
$Q_G$	Gate charge	$V_{CC}=600\text{ V}$ , $I_C=2500\text{ A}$ , $V_{GE}=15\text{ V}$	-	5800	-	nC	
$t_{d(on)}$	Turn-on delay time	$V_{CC}=600\text{ V}$ , $I_C=2500\text{ A}$ , $V_{GE}=\pm 15\text{ V}$ , $R_G=0\text{ }\Omega$ , Inductive load	-	-	800	ns	
$t_r$	Rise time		-	-	200		
$t_{d(off)}$	Turn-off delay time		-	-	700		
$t_f$	Fall time		-	-	300		
$V_{EC}$ (Note1) (Terminal)	Emitter-collector voltage	$I_E=2500\text{ A}$ , G-E short-circuited, Refer to the figure of test circuit (Note5)	$T_j=25\text{ }^\circ\text{C}$	-	1.80	2.25	V
			$T_j=125\text{ }^\circ\text{C}$	-	1.80	-	
			$T_j=150\text{ }^\circ\text{C}$	-	1.80	-	
$V_{EC}$ (Note1) (Chip)		$I_E=2500\text{ A}$ , G-E short-circuited, (Note5)	$T_j=25\text{ }^\circ\text{C}$	-	1.70	2.15	V
			$T_j=125\text{ }^\circ\text{C}$	-	1.70	-	
			$T_j=150\text{ }^\circ\text{C}$	-	1.70	-	
$t_{rr}$ (Note1)	Reverse recovery time	$V_{CC}=600\text{ V}$ , $I_E=2500\text{ A}$ , $V_{GE}=\pm 15\text{ V}$ ,	-	-	300	ns	
$Q_{rr}$ (Note1)	Reverse recovery charge	$R_G=0\text{ }\Omega$ , Inductive load	-	70	-	$\mu\text{C}$	
$E_{on}$	Turn-on switching energy per pulse	$V_{CC}=600\text{ V}$ , $I_C=I_E=2500\text{ A}$ ,	-	174	-	mJ	
$E_{off}$	Turn-off switching energy per pulse	$V_{GE}=\pm 15\text{ V}$ , $R_G=0\text{ }\Omega$ ,	-	259	-		
$E_{rr}$ (Note1)	Reverse recovery energy per pulse	$T_j=150\text{ }^\circ\text{C}$ , Inductive load	-	195	-	mJ	
$R_{CC'+EE'}$	Internal lead resistance	Main terminals -chip, per switch, $T_C=25\text{ }^\circ\text{C}$ (Note4)	-	0.11	-	m $\Omega$	
$r_g$	Internal gate resistance	Per switch	-	1.1	-	$\Omega$	

< IGBT MODULES >

CM2500DY-24S

HIGH POWER SWITCHING USE  
INSULATED TYPE

ELECTRICAL CHARACTERISTICS (cont.; T<sub>J</sub>=25 °C, unless otherwise specified)

NTC THERMISTOR PART

Symbol	Item	Conditions	Limits			Unit
			Min.	Typ.	Max.	
R <sub>25</sub>	Zero-power resistance	T <sub>C</sub> =25 °C (Note4)	4.85	5.00	5.15	kΩ
ΔR/R	Deviation of resistance	R <sub>100</sub> =493 Ω, T <sub>C</sub> =100 °C (Note4)	-7.3	-	+7.8	%
B <sub>(25/50)</sub>	B-constant	Approximate by equation (Note6)	-	3375	-	K
P <sub>25</sub>	Power dissipation	T <sub>C</sub> =25 °C (Note4)	-	-	10	mW

THERMAL RESISTANCE CHARACTERISTICS

Symbol	Item	Conditions	Limits			Unit
			Min.	Typ.	Max.	
R <sub>th(j-c)Q</sub>	Thermal resistance	Junction to case, per IGBT (Note4)	-	-	13	K/kW
R <sub>th(j-c)D</sub>		Junction to case, per DIODE (Note4)	-	-	22	K/kW
R <sub>th(c-s)</sub>	Contact thermal resistance	Case to heat sink, per 1 module, Thermal grease applied (Note4, 7)	-	3.1	-	K/kW

MECHANICAL CHARACTERISTICS

Symbol	Item	Conditions	Limits			Unit
			Min.	Typ.	Max.	
M <sub>t</sub>	Mounting torque	Main terminals M 6 screw	3.5	4.0	4.5	N·m
M <sub>t</sub>		Auxiliary terminals M 4 screw	1.3	1.5	1.7	
M <sub>s</sub>		Mounting to heat sink M 5 screw	2.5	3.0	3.5	
d <sub>s</sub>	Creepage distance	Terminal to terminal	16	-	-	mm
		Terminal to base plate	25	-	-	
d <sub>a</sub>	Clearance	Terminal to terminal	16	-	-	mm
		Terminal to base plate	24	-	-	
m	mass	-	-	2	kg	
e <sub>c</sub>	Flatness of base plate	On the centerline X, Y (Note8)	-50	-	+100	μm

Note1. Represent ratings and characteristics of the anti-parallel, emitter-collector free wheeling diode (DIODE).

2. Junction temperature (T<sub>J</sub>) should not increase beyond T<sub>Jmax</sub> rating.

3. Pulse width and repetition rate should be such that the device junction temperature (T<sub>J</sub>) dose not exceed T<sub>Jmax</sub> rating.

4. Case temperature (T<sub>C</sub>) and heat sink temperature (T<sub>S</sub>) are defined on the each surface (mounting side) of base plate and heat sink just under the chips. Refer to the figure of chip location.

The heat sink thermal resistance should measure just under the chips.

5. Pulse width and repetition rate should be such as to cause negligible temperature rise.

$$6. B_{(25/50)} = \ln\left(\frac{R_{25}}{R_{50}}\right) / \left(\frac{1}{T_{25}} - \frac{1}{T_{50}}\right)$$

R<sub>25</sub>: resistance at absolute temperature T<sub>25</sub> [K]; T<sub>25</sub>=25 [°C]+273.15=298.15 [K]

R<sub>50</sub>: resistance at absolute temperature T<sub>50</sub> [K]; T<sub>50</sub>=50 [°C]+273.15=323.15 [K]

7. Typical value is measured by using thermally conductive grease of λ=0.9 W/(m·K).

8. Base plate (mounting side) flatness measurement points (X, Y) are as follows of the following figure.

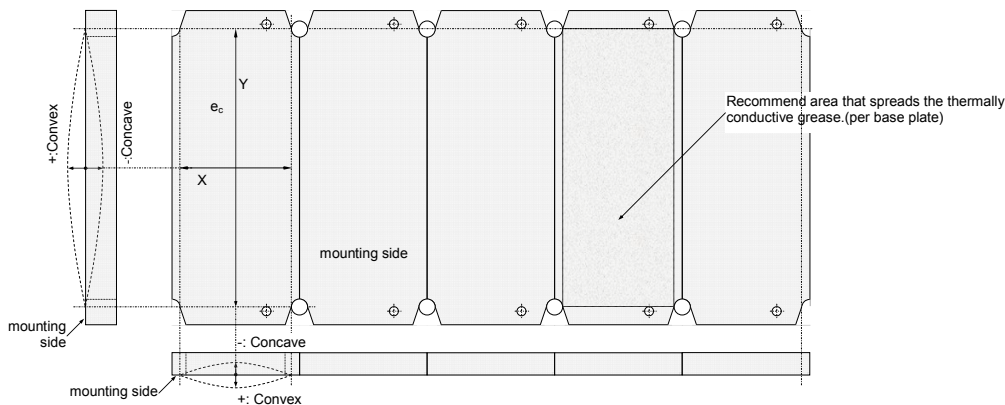

9. Main terminal pair should be connected together in case of the current through it.

< IGBT MODULES >

CM2500DY-24S

HIGH POWER SWITCHING USE  
INSULATED TYPE

RECOMMENDED OPERATING CONDITIONS

Symbol	Item	Conditions	Limits			Unit
			Min.	Typ.	Max.	
V <sub>CC</sub>	(DC) Supply voltage	Applied across C1-E2	-	600	850	V
V <sub>GEon</sub>	Gate (-emitter drive) voltage	Applied across G1-Es1/G2-Es2	13.5	15.0	16.5	V
R <sub>G</sub>	External gate resistance	Per switch	0	-	2	Ω

CHIP LOCATION (Top view)

Dimension in mm, tolerance: ±1 mm

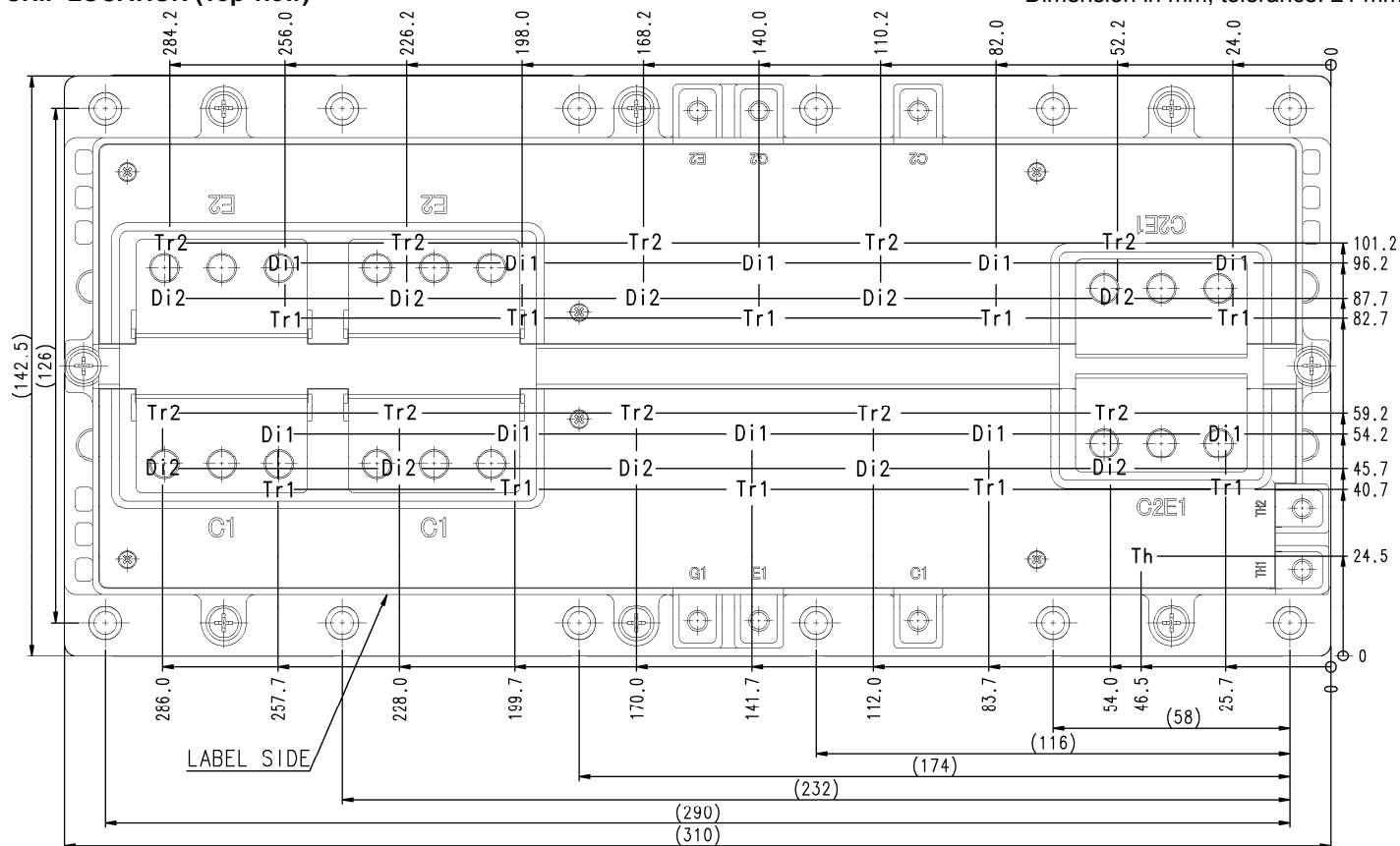

Tr1/Tr2: IGBT, Di1/Di2: DIODE, Th: NTC thermistor

TEST CIRCUIT

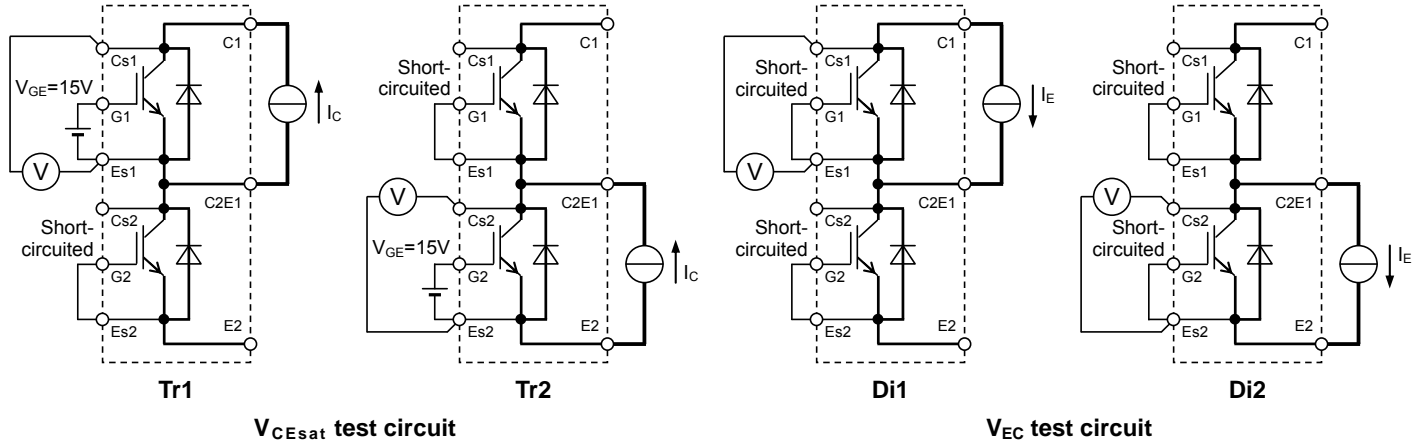

TEST CIRCUIT AND WAVEFORMS

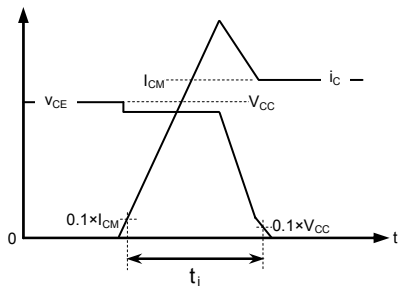
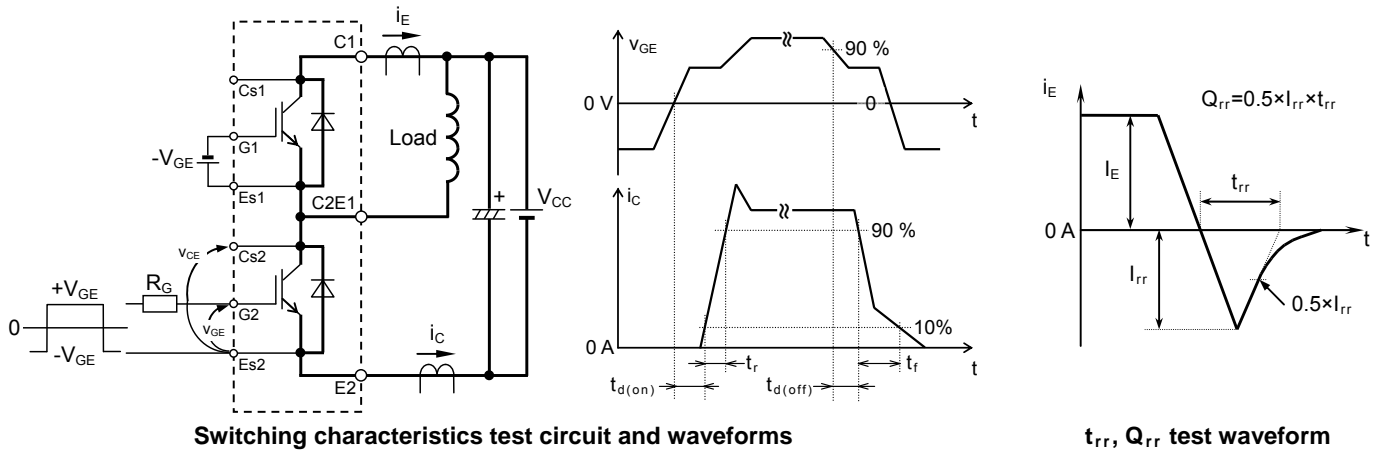

IGBT Turn-on switching energy

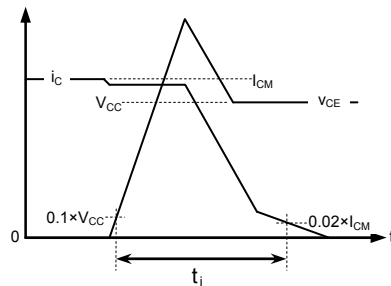

IGBT Turn-off switching energy

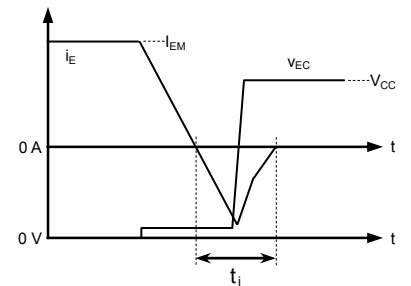

DIODE Reverse recovery energy

Turn-on / Turn-off switching energy and Reverse recovery energy test waveforms (Integral time instruction drawing)

< IGBT MODULES >  
**CM2500DY-24S**  
 HIGH POWER SWITCHING USE  
 INSULATED TYPE

PERFORMANCE CURVES

OUTPUT CHARACTERISTICS  
(TYPICAL)

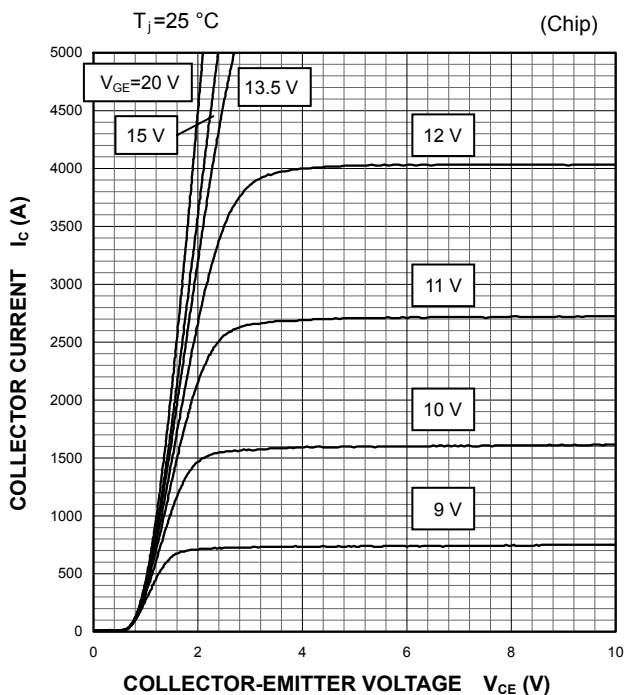

COLLECTOR-EMITTER SATURATION  
VOLTAGE CHARACTERISTICS  
(TYPICAL)

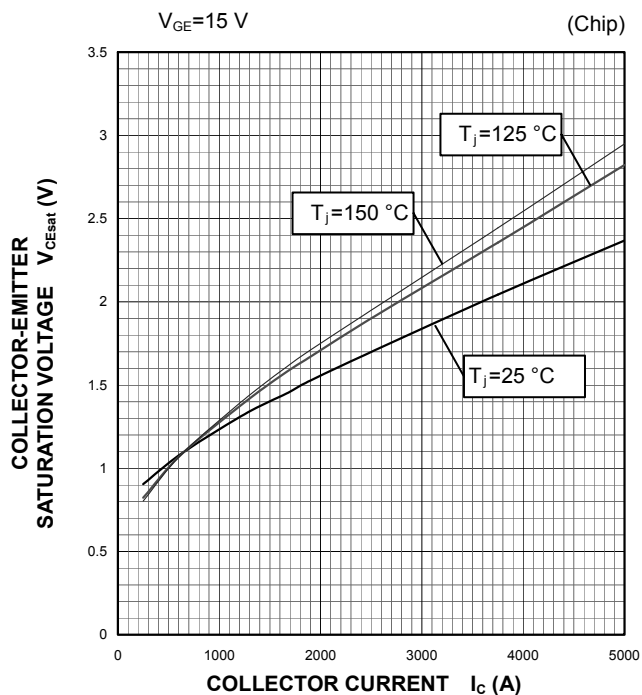

COLLECTOR-EMITTER SATURATION  
VOLTAGE CHARACTERISTICS  
(TYPICAL)

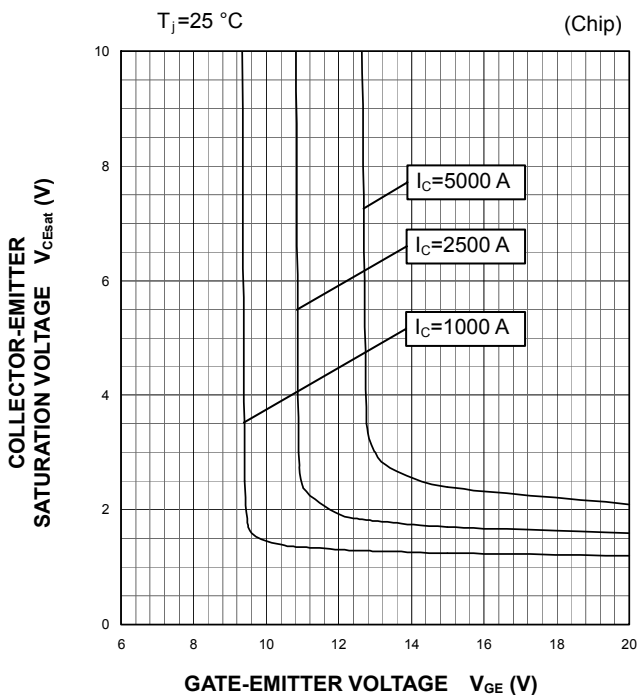

FREE WHEELING DIODE  
FORWARD CHARACTERISTICS  
(TYPICAL)

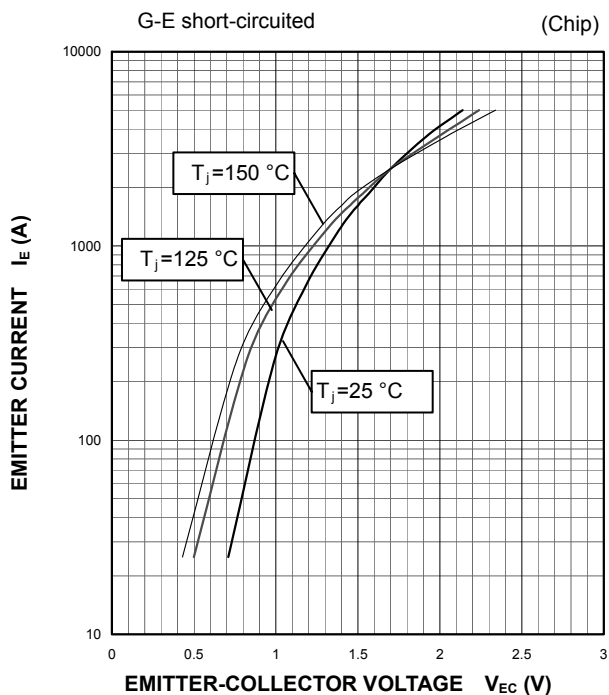

PERFORMANCE CURVES

HALF-BRIDGE  
SWITCHING CHARACTERISTICS  
(TYPICAL)

$V_{CC}=600\text{ V}$ ,  $V_{GE}=\pm 15\text{ V}$ ,  $R_G=0\ \Omega$ , INDUCTIVE LOAD  
——:  $T_J=150\text{ }^\circ\text{C}$ , - - - -:  $T_J=125\text{ }^\circ\text{C}$

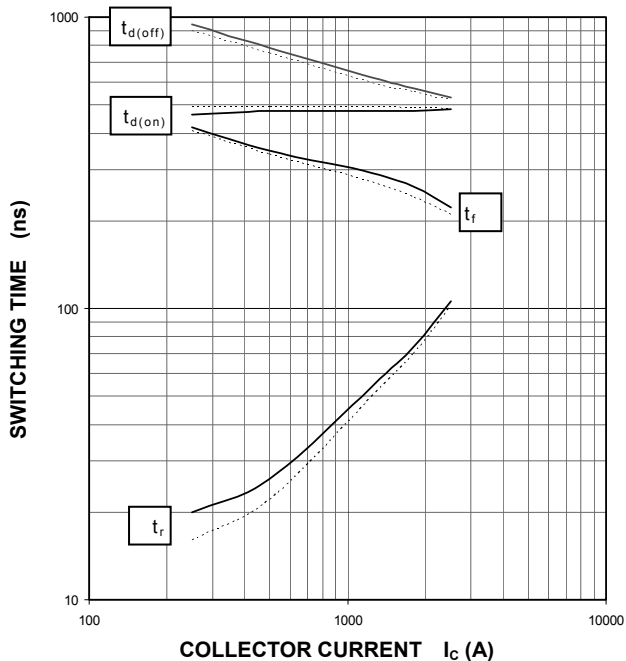

HALF-BRIDGE  
SWITCHING CHARACTERISTICS  
(TYPICAL)

$V_{CC}=600\text{ V}$ ,  $I_C=2500\text{ A}$ ,  $V_{GE}=\pm 15\text{ V}$ , INDUCTIVE LOAD  
——:  $T_J=150\text{ }^\circ\text{C}$ , - - - -:  $T_J=125\text{ }^\circ\text{C}$

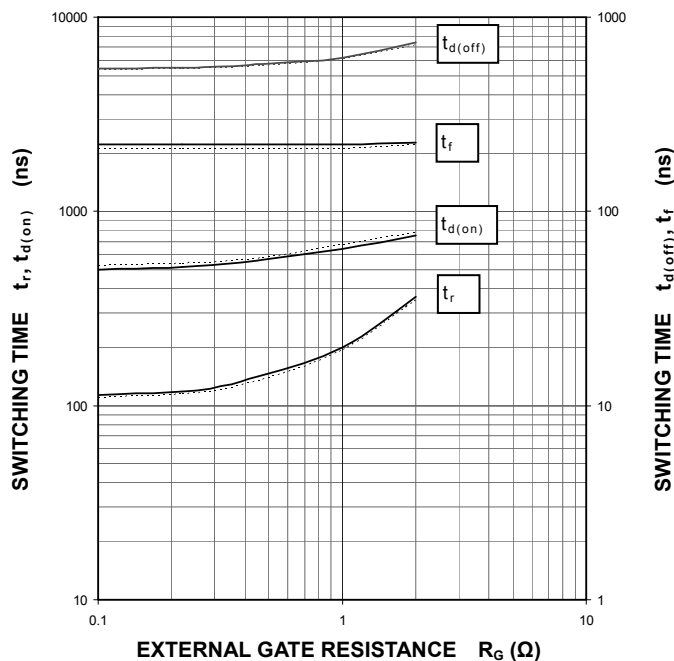

HALF-BRIDGE  
SWITCHING CHARACTERISTICS  
(TYPICAL)

$V_{CC}=600\text{ V}$ ,  $V_{GE}=\pm 15\text{ V}$ ,  $R_G=0\ \Omega$ ,  
INDUCTIVE LOAD, PER PULSE  
——:  $T_J=150\text{ }^\circ\text{C}$ , - - - -:  $T_J=125\text{ }^\circ\text{C}$

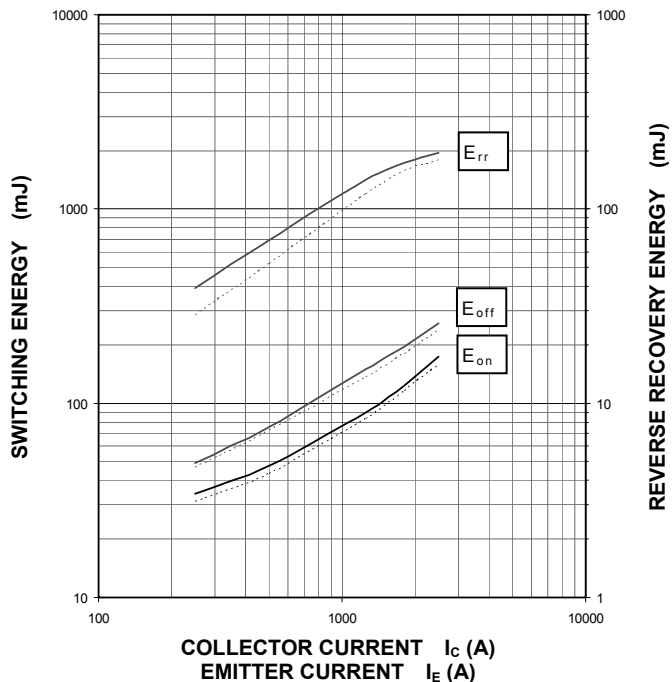

HALF-BRIDGE  
SWITCHING CHARACTERISTICS  
(TYPICAL)

$V_{CC}=600\text{ V}$ ,  $I_C/I_E=2500\text{ A}$ ,  $V_{GE}=\pm 15\text{ V}$ ,  
INDUCTIVE LOAD, PER PULSE  
——:  $T_J=150\text{ }^\circ\text{C}$ , - - - -:  $T_J=125\text{ }^\circ\text{C}$

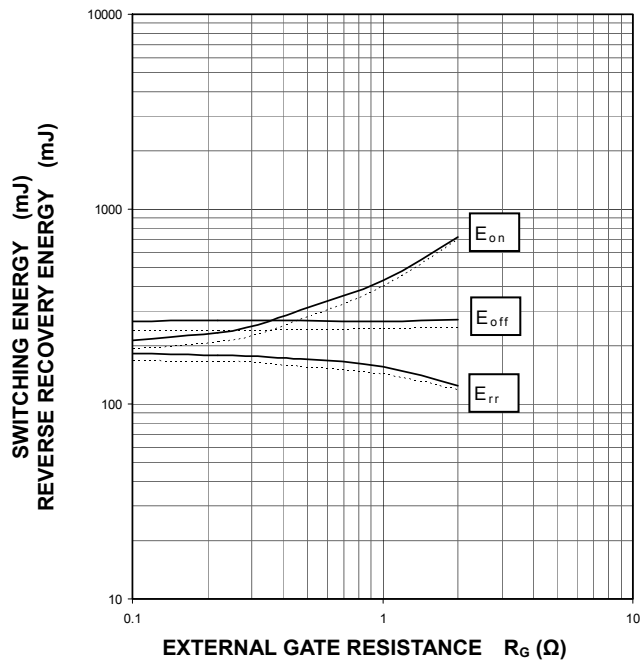

< IGBT MODULES >  
**CM2500DY-24S**  
 HIGH POWER SWITCHING USE  
 INSULATED TYPE

**PERFORMANCE CURVES**

**CAPACITANCE CHARACTERISTICS (TYPICAL)**

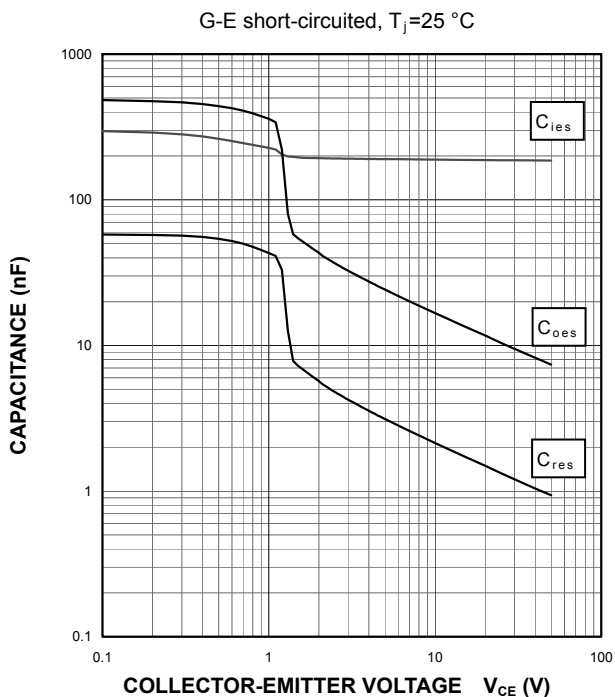

**FREE WHEELING DIODE REVERSE RECOVERY CHARACTERISTICS (TYPICAL)**

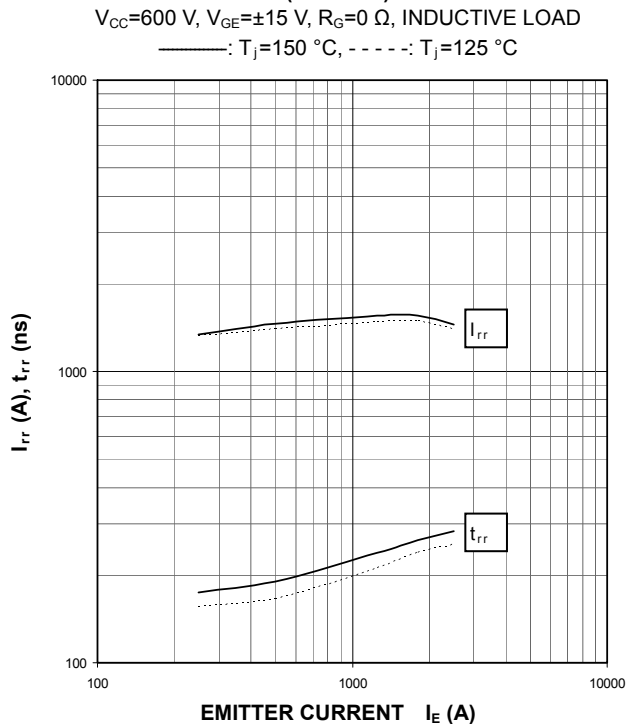

**GATE CHARGE CHARACTERISTICS (TYPICAL)**

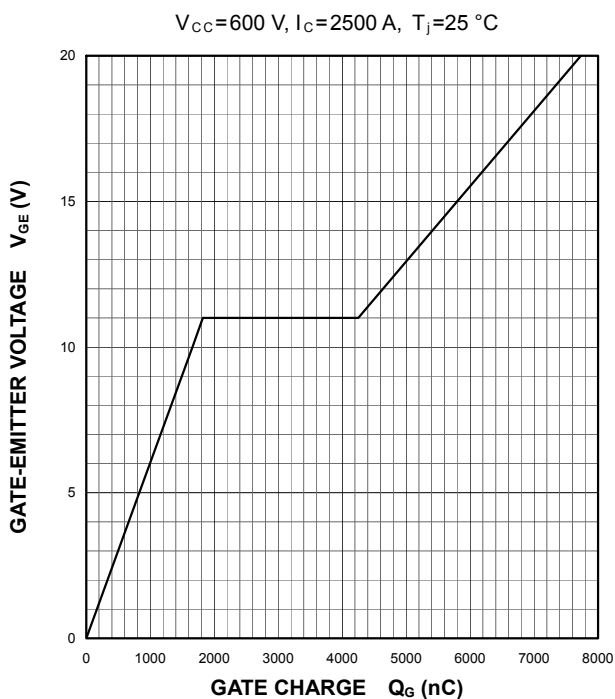

**TRANSIENT THERMAL IMPEDANCE CHARACTERISTICS (MAXIMUM)**

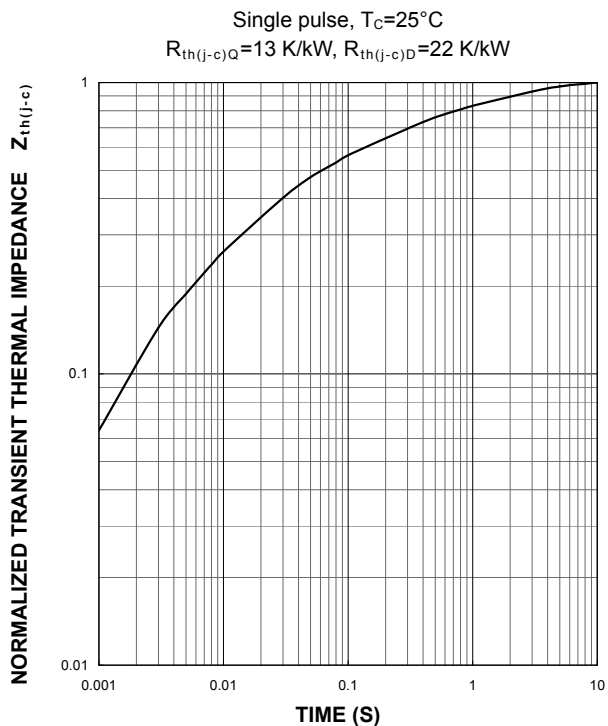



< IGBT MODULES >  
CM2500DY-24S  
HIGH POWER SWITCHING USE  
INSULATED TYPE

---

PERFORMANCE CURVES

NTC thermistor part

TEMPERATURE CHARACTERISTICS

(TYPICAL)

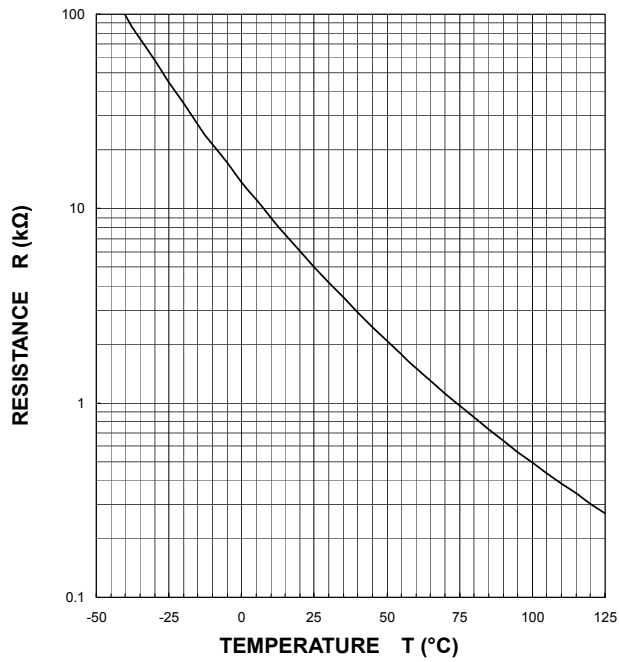

### **Keep safety first in your circuit designs!**

Mitsubishi Electric Corporation puts the maximum effort into making semiconductor products better and more reliable, but there is always the possibility that trouble may occur with them. Trouble with semiconductors may lead to personal injury, fire or property damage. Remember to give due consideration to safety when making your circuit designs, with appropriate measures such as (i) placement of substitutive, auxiliary circuits, (ii) use of non-flammable material or (iii) prevention against any malfunction or mishap.

### **Notes regarding these materials**

- These materials are intended as a reference to assist our customers in the selection of the Mitsubishi semiconductor product best suited to the customer's application; they do not convey any license under any intellectual property rights, or any other rights, belonging to Mitsubishi Electric Corporation or a third party.
- Mitsubishi Electric Corporation assumes no responsibility for any damage, or infringement of any third-party's rights, originating in the use of any product data, diagrams, charts, programs, algorithms, or circuit application examples contained in these materials.
- All information contained in these materials, including product data, diagrams, charts, programs and algorithms represents information on products at the time of publication of these materials, and are subject to change by Mitsubishi Electric Corporation without notice due to product improvements or other reasons. It is therefore recommended that customers contact Mitsubishi Electric Corporation or an authorized Mitsubishi Semiconductor product distributor for the latest product information before purchasing a product listed herein.  
The information described here may contain technical inaccuracies or typographical errors. Mitsubishi Electric Corporation assumes no responsibility for any damage, liability, or other loss rising from these inaccuracies or errors.  
Please also pay attention to information published by Mitsubishi Electric Corporation by various means, including the Mitsubishi Semiconductor home page ([www.MitsubishiElectric.com/semiconductors/](http://www.MitsubishiElectric.com/semiconductors/)).
- When using any or all of the information contained in these materials, including product data, diagrams, charts, programs, and algorithms, please be sure to evaluate all information as a total system before making a final decision on the applicability of the information and products. Mitsubishi Electric Corporation assumes no responsibility for any damage, liability or other loss resulting from the information contained herein.
- Mitsubishi Electric Corporation semiconductors are not designed or manufactured for use in a device or system that is used under circumstances in which human life is potentially at stake. Please contact Mitsubishi Electric Corporation or an authorized Mitsubishi Semiconductor product distributor when considering the use of a product contained herein for any specific purposes, such as apparatus or systems for transportation, vehicular, medical, aerospace, nuclear, or undersea repeater use.
- The prior written approval of Mitsubishi Electric Corporation is necessary to reprint or reproduce in whole or in part these materials.
- If these products or technologies are subject to the Japanese export control restrictions, they must be exported under a license from the Japanese government and cannot be imported into a country other than the approved destination.  
Any diversion or reexport contrary to the export control laws and regulations of Japan and/or the country of destination is prohibited.
- Please contact Mitsubishi Electric Corporation or an authorized Mitsubishi Semiconductor product distributor for further details on these materials or the products contained therein.