

MITSUBISHI IGBT MODULES

CM300DY-24H

HIGH POWER SWITCHING USE
INSULATED TYPE

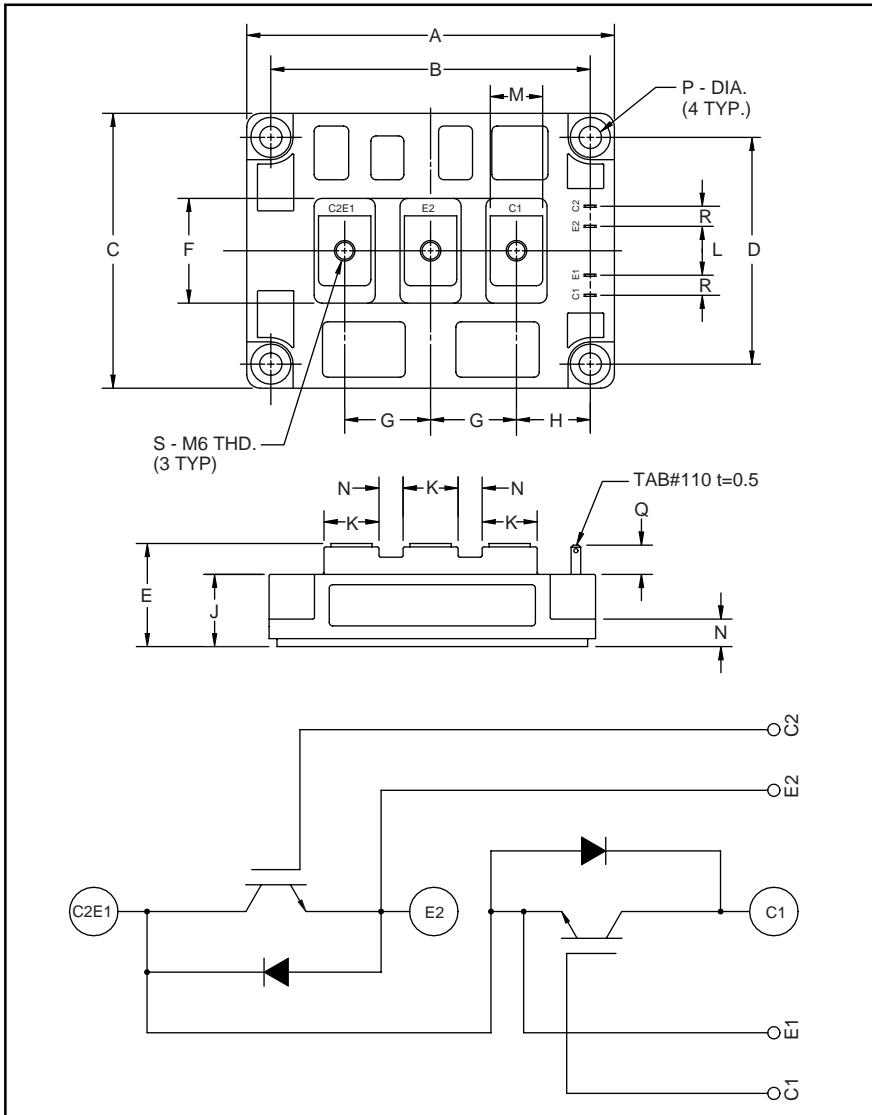

Outline Drawing and Circuit Diagram

Dimensions	Inches	Millimeters
A	4.33	110.0
B	3.661±0.01	93.0±0.25
C	3.15	80.0
D	2.441±0.01	62.0±0.25
E	1.18 Max.	30.0 Max.
F	1.18	30.0
G	0.98	25.0
H	0.85	21.5
J	0.83	21.2

Dimensions	Inches	Millimeters
K	0.71	18.0
L	0.59	15.0
M	0.55	14.0
N	0.28	7.0
P	0.26 Dia.	Dia. 6.5
Q	0.33	8.5
R	0.24	6.0
S	M6 Metric	M6

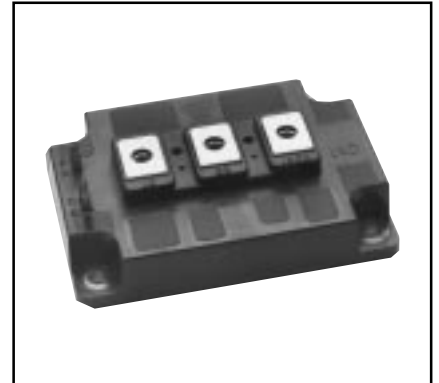

Description:

Mitsubishi IGBT Modules are designed for use in switching applications. Each module consists of two IGBTs in a half-bridge configuration with each transistor having a reverse-connected super-fast recovery free-wheel diode. All components and interconnects are isolated from the heat sinking baseplate, offering simplified system assembly and thermal management.

Features:

- Low Drive Power
- Low $V_{CE(sat)}$
- Discrete Super-Fast Recovery Free-Wheel Diode
- High Frequency Operation
- Isolated Baseplate for Easy Heat Sinking

Applications:

- AC Motor Control
- Motion/Servo Control
- UPS
- Welding Power Supplies

Ordering Information:

Example: Select the complete part module number you desire from the table below -i.e. CM300DY-24H is a 1200V (V_{CES}), 300 Ampere Dual IGBT Module.

Type	Current Rating Amperes	V_{CES} Volts (x 50)
CM	300	24

CM300DY-24H

HIGH POWER SWITCHING USE
INSULATED TYPEAbsolute Maximum Ratings, $T_j = 25\text{ }^\circ\text{C}$ unless otherwise specified

Ratings	Symbol	CM300DY-24H	Units
Junction Temperature	T_j	-40 to 150	$^\circ\text{C}$
Storage Temperature	T_{stg}	-40 to 125	$^\circ\text{C}$
Collector-Emitter Voltage (G-E SHORT)	V_{CES}	1200	Volts
Gate-Emitter Voltage (C-E SHORT)	V_{GES}	± 20	Volts
Collector Current ($T_C = 25^\circ\text{C}$)	I_C	300	Amperes
Peak Collector Current	I_{CM}	600*	Amperes
Emitter Current** ($T_C = 25^\circ\text{C}$)	I_E	300	Amperes
Peak Emitter Current**	I_{EM}	600*	Amperes
Maximum Collector Dissipation ($T_C = 25^\circ\text{C}$, $T_j \leq 150^\circ\text{C}$)	P_c	2100	Watts
Mounting Torque, M6 Main Terminal	-	1.96 ~ 2.94	N · m
Mounting Torque, M6 Mounting	-	1.96 ~ 2.94	N · m
Weight	-	500	Grams
Isolation Voltage (Main Terminal to Baseplate, AC 1 min.)	V_{iso}	2500	Vrms

*Pulse width and repetition rate should be such that the device junction temperature (T_j) does not exceed $T_{j(max)}$ rating.

**Represents characteristics of the anti-parallel, emitter-to-collector free-wheel diode (FWDi).

Static Electrical Characteristics, $T_j = 25\text{ }^\circ\text{C}$ unless otherwise specified

Characteristics	Symbol	Test Conditions	Min.	Typ.	Max.	Units
Collector-Cutoff Current	I_{CES}	$V_{CE} = V_{CES}$, $V_{GE} = 0V$	-	-	1.0	mA
Gate Leakage Current	I_{GES}	$V_{GE} = V_{GES}$, $V_{CE} = 0V$	-	-	0.5	μA
Gate-Emitter Threshold Voltage	$V_{GE(th)}$	$I_C = 30\text{mA}$, $V_{CE} = 10V$	4.5	6.0	7.5	Volts
Collector-Emitter Saturation Voltage	$V_{CE(sat)}$	$I_C = 300\text{A}$, $V_{GE} = 15V$	-	2.5	3.4**	Volts
		$I_C = 300\text{A}$, $V_{GE} = 15V$, $T_j = 150^\circ\text{C}$	-	2.25	-	Volts
Total Gate Charge	Q_G	$V_{CC} = 600V$, $I_C = 300\text{A}$, $V_{GE} = 15V$	-	1500	-	nC
Emitter-Collector Voltage	V_{EC}	$I_E = 300\text{A}$, $V_{GE} = 0V$	-	-	3.5	Volts

** Pulse width and repetition rate should be such that device junction temperature rise is negligible.

Dynamic Electrical Characteristics, $T_j = 25\text{ }^\circ\text{C}$ unless otherwise specified

Characteristics	Symbol	Test Conditions	Min.	Typ.	Max.	Units
Input Capacitance	C_{ies}		-	-	60	nF
Output Capacitance	C_{oes}	$V_{GE} = 0V$, $V_{CE} = 10V$	-	-	21	nF
Reverse Transfer Capacitance	C_{res}		-	-	12	nF
Resistive	Turn-on Delay Time	$V_{CC} = 600V$, $I_C = 300\text{A}$,	-	-	250	ns
	Rise Time					
Load	Turn-off Delay Time	$V_{GE1} = V_{GE2} = 15V$, $R_G = 1.0\Omega$	-	-	350	ns
	Fall Time					
Diode Reverse Recovery Time	t_{rr}	$I_E = 300\text{A}$, $di_E/dt = -600\text{A}/\mu\text{s}$	-	-	250	ns
Diode Reverse Recovery Charge	Q_{rr}	$I_E = 300\text{A}$, $di_E/dt = -600\text{A}/\mu\text{s}$	-	2.23	-	μC

Thermal and Mechanical Characteristics, $T_j = 25\text{ }^\circ\text{C}$ unless otherwise specified

Characteristics	Symbol	Test Conditions	Min.	Typ.	Max.	Units
Thermal Resistance, Junction to Case	$R_{th(j-c)}$	Per IGBT	-	-	0.06	$^\circ\text{C}/W$
Thermal Resistance, Junction to Case	$R_{th(j-c)}$	Per FWDi	-	-	0.12	$^\circ\text{C}/W$
Contact Thermal Resistance	$R_{th(c-f)}$	Per Module, Thermal Grease Applied	-	-	0.035	$^\circ\text{C}/W$

CM300DY-24H

HIGH POWER SWITCHING USE
INSULATED TYPE

OUTPUT CHARACTERISTICS
(TYPICAL)

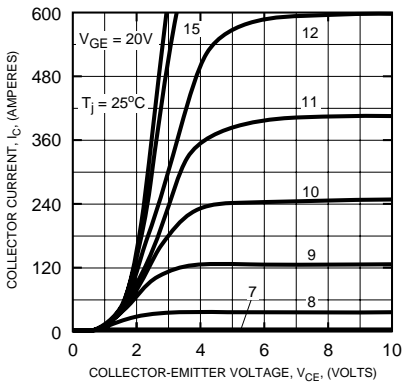

TRANSFER CHARACTERISTICS
(TYPICAL)

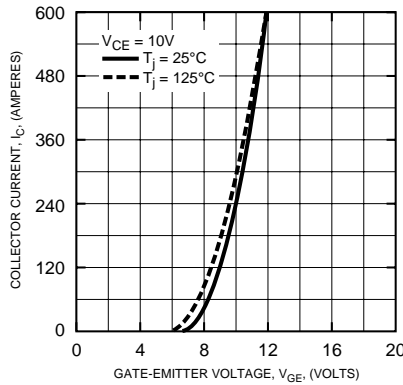

COLLECTOR-EMITTER SATURATION VOLTAGE CHARACTERISTICS
(TYPICAL)

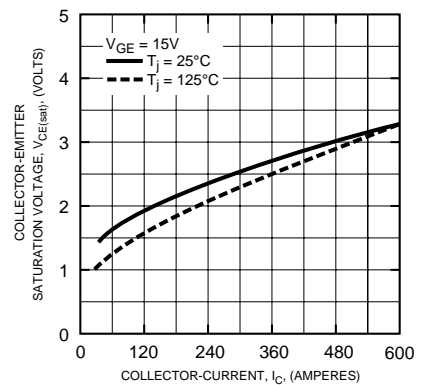

COLLECTOR-EMITTER SATURATION VOLTAGE CHARACTERISTICS
(TYPICAL)

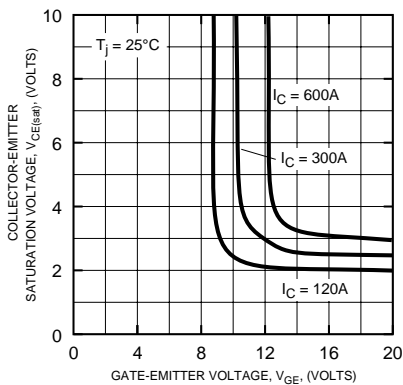

FREE-WHEEL DIODE FORWARD CHARACTERISTICS
(TYPICAL)

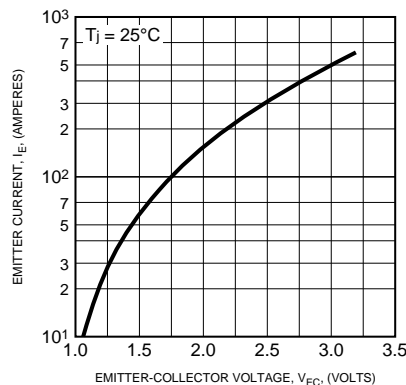

CAPACITANCE VS. V_{CE}
(TYPICAL)

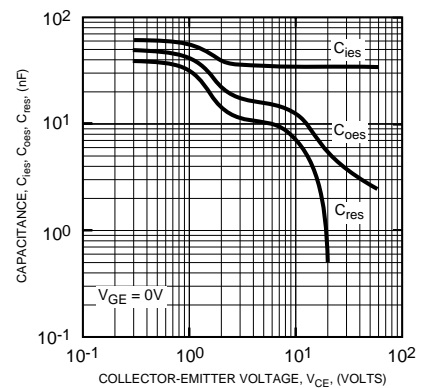

HALF-BRIDGE SWITCHING CHARACTERISTICS
(TYPICAL)

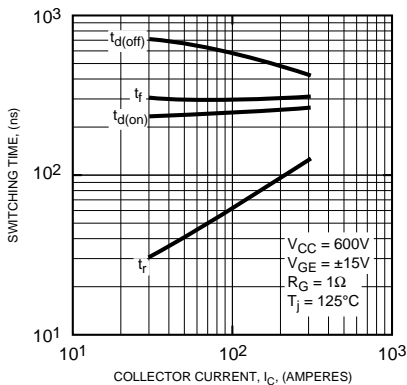

REVERSE RECOVERY CHARACTERISTICS
(TYPICAL)

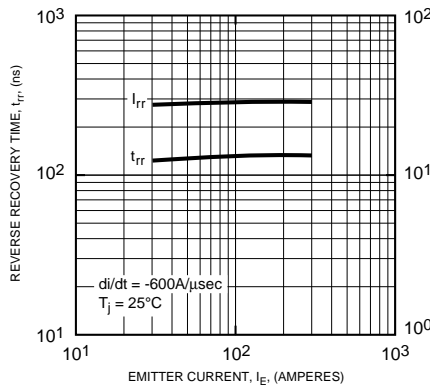

GATE CHARGE, V_{GE}

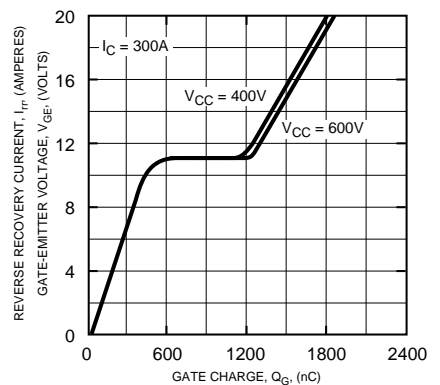

CM300DY-24H

HIGH POWER SWITCHING USE
INSULATED TYPE

