

< IGBT MODULES >

CM600DY-24S

HIGH POWER SWITCHING USE
INSULATED TYPE



Dual switch (Half-Bridge)

Collector current I_C **600 A**
 Collector-emitter voltage V_{CES} **1200 V**
 Maximum junction temperature T_{jmax} **175 °C**

- Flat base Type
- Copper base plate
- RoHS Directive compliance
- UL Recognized under UL1557, File E323585

APPLICATION

AC Motor Control, Motion/Servo Control, Power supply, etc.

OUTLINE DRAWING & INTERNAL CONNECTION

Dimension in mm

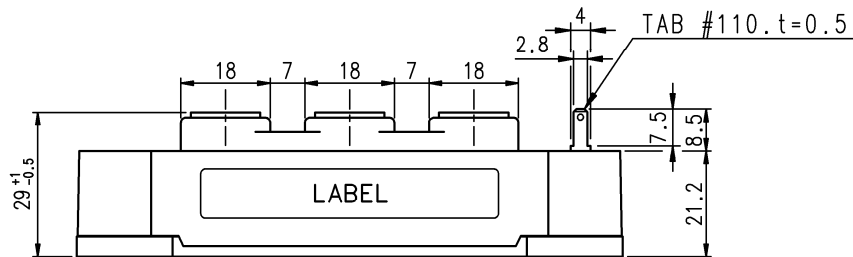
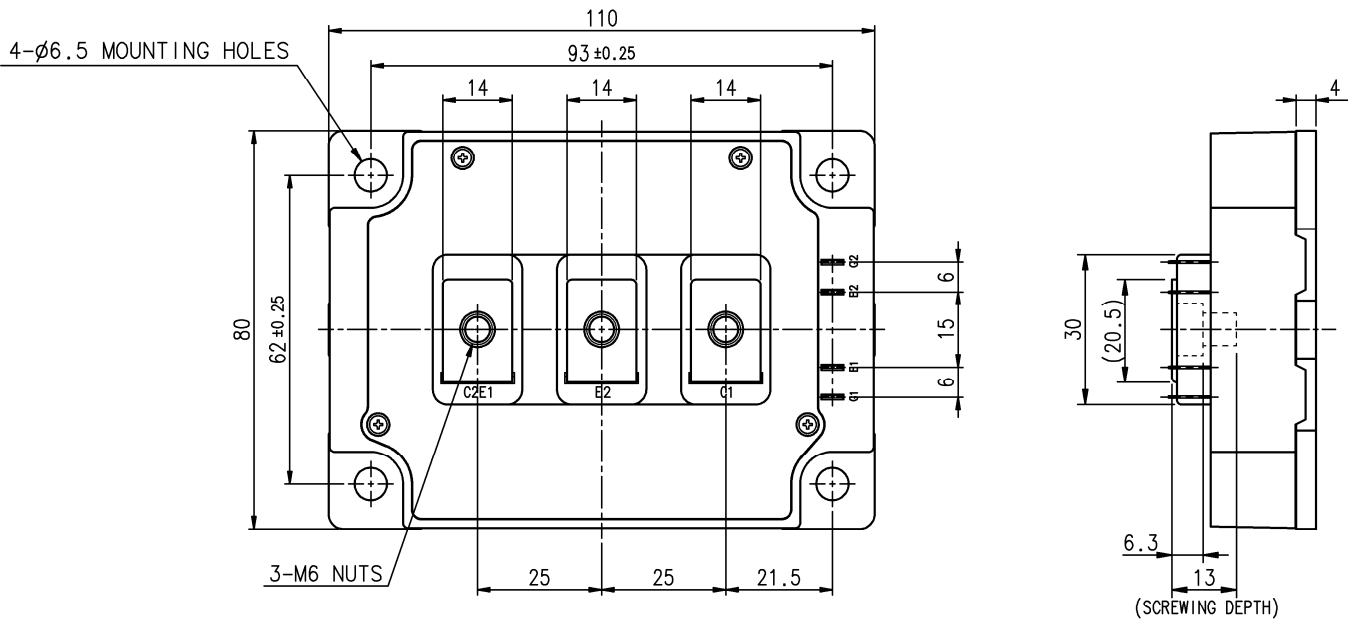

Tolerance otherwise specified

Division of Dimension	Tolerance
0.5 to 3	±0.2
over 3 to 6	±0.3
over 6 to 30	±0.5
over 30 to 120	±0.8
over 120 to 400	±1.2

INTERNAL CONNECTION

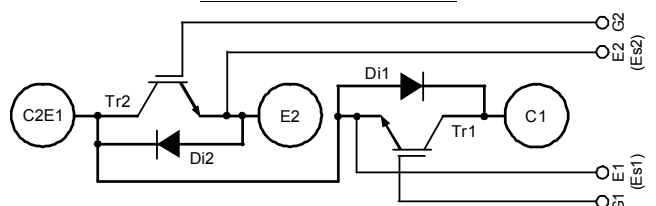

< IGBT MODULES >

CM600DY-24S

HIGH POWER SWITCHING USE
INSULATED TYPE

ABSOLUTE MAXIMUM RATINGS (T_j=25 °C, unless otherwise specified)

Symbol	Item	Conditions	Rating	Unit
V _{CES}	Collector-emitter voltage	G-E short-circuited	1200	V
V _{GES}	Gate-emitter voltage	C-E short-circuited	± 20	V
I _C	Collector current	DC, T _C =112 °C (Note2, 4)	600	A
I _{CRM}		Pulse, Repetitive (Note3)	1200	
P _{tot}	Total power dissipation	T _C =25 °C (Note2, 4)	4050	W
I _E (Note1)	Emitter current	(Note2)	600	A
I _{ERM} (Note1)		Pulse, Repetitive (Note3)	1200	
V _{isol}	Isolation voltage	Terminals to base plate, RMS, f=60 Hz, AC 1 min	2500	V
T _{jmax}	Maximum junction temperature	Instantaneous event (overload)	175	°C
T _{cmax}	Maximum case temperature	(Note4)	125	
T _{jopr}	Operating junction temperature	Continuous operation (under switching)	-40 ~ +150	°C
T _{stg}	Storage temperature	-	-40 ~ +125	

ELECTRICAL CHARACTERISTICS (T_j=25 °C, unless otherwise specified)

Symbol	Item	Conditions	Limits			Unit	
			Min.	Typ.	Max.		
I _{CES}	Collector-emitter cut-off current	V _{CE} =V _{CES} , G-E short-circuited	-	-	1.0	mA	
I _{GES}	Gate-emitter leakage current	V _{GE} =V _{GES} , C-E short-circuited	-	-	0.5	µA	
V _{GE(th)}	Gate-emitter threshold voltage	I _C =60 mA, V _{CE} =10 V	5.4	6.0	6.6	V	
V _{CESat}	Collector-emitter saturation voltage	I _C =600 A (Note5), V _{GE} =15 V, Terminal	T _j =25 °C	-	1.85	2.25	V
			T _j =125 °C	-	2.05	-	
			T _j =150 °C	-	2.10	-	
		I _C =600 A (Note5), V _{GE} =15 V, Chip	T _j =25 °C	-	1.70	2.15	V
			T _j =125 °C	-	1.90	-	
			T _j =150 °C	-	1.95	-	
C _{ies}	Input capacitance	V _{CE} =10 V, G-E short-circuited	-	-	60	nF	
C _{oes}	Output capacitance		-	-	12		
C _{res}	Reverse transfer capacitance		-	-	1.0		
Q _G	Gate charge	V _{CC} =600 V, I _C =600 A, V _{GE} =15 V	-	1400	-	nC	
t _{d(on)}	Turn-on delay time	V _{CC} =600 V, I _C =600 A, V _{GE} =±15 V, R _G =0 Ω, Inductive load	-	-	800	ns	
t _r	Rise time		-	-	200		
t _{d(off)}	Turn-off delay time		-	-	600		
t _f	Fall time		-	-	300		
V _{EC} (Note.1)	Emitter-collector voltage	I _E =600 A (Note5), G-E short-circuited, Terminal	T _j =25 °C	-	1.80	2.25	V
			T _j =125 °C	-	1.80	-	
			T _j =150 °C	-	1.80	-	
		I _E =600 A (Note5), G-E short-circuited, Chip	T _j =25 °C	-	1.70	2.15	V
			T _j =125 °C	-	1.70	-	
			T _j =150 °C	-	1.70	-	
t _{rr} (Note.1)	Reverse recovery time	V _{CC} =600 V, I _E =600 A, V _{GE} =±15 V, R _G =0 Ω, Inductive load	-	-	300	ns	
Q _{rr} (Note.1)	Reverse recovery charge	R _G =0 Ω, Inductive load	-	32	-	µC	
E _{on}	Turn-on switching energy per pulse	V _{CC} =600 V, I _C =I _E =600 A, V _{GE} =±15 V, R _G =0 Ω,	-	65.9	-	mJ	
E _{off}	Turn-off switching energy per pulse	T _j =150 °C, Inductive load	-	79.1	-		
E _{rr} (Note.1)	Reverse recovery energy per pulse	T _j =150 °C, Inductive load	-	55.2	-	mJ	
r _g	Internal gate resistance	Per switch	-	3.3	-	Ω	

< IGBT MODULES >

CM600DY-24S

HIGH POWER SWITCHING USE
INSULATED TYPE

THERMAL RESISTANCE CHARACTERISTICS

Symbol	Item	Conditions	Limits			Unit
			Min.	Typ.	Max.	
$R_{th(j-c)Q}$	Thermal resistance (Note4)	Junction to case, per IGBT	-	-	37	K/kW
$R_{th(j-c)D}$		Junction to case, per FWDi	-	-	60	K/kW
$R_{th(c-s)}$	Contact thermal resistance (Note4)	Case to heat sink, per 1/2 module, Thermal grease applied (Note6)	-	18	-	K/kW

MECHANICAL CHARACTERISTICS

Symbol	Item	Conditions	Limits			Unit
			Min.	Typ.	Max.	
M_t	Mounting torque	Main terminals M 6 screw	3.5	4.0	4.5	N·m
M_s		Mounting to heat sink M 6 screw	3.5	4.0	4.5	N·m
m	Weight	-	-	580	-	g
e_c	Flatness of base plate	On the centerline X, Y (Note7)	-100	-	+100	μm

Note1. Represent ratings and characteristics of the anti-parallel, emitter-collector free wheeling diode (FWDi).

2. Junction temperature (T_j) should not increase beyond T_{jmax} rating.

3. Pulse width and repetition rate should be such that the device junction temperature (T_j) dose not exceed T_{jmax} rating.

4. Case temperature (T_c) and heat sink temperature (T_s) are defined on the each surface (mounting side) of base plate and heat sink just under the chips. Refer to the figure of chip location.

The heat sink thermal resistance should measure just under the chips.

5. Pulse width and repetition rate should be such as to cause negligible temperature rise. Refer to the figure of test circuit.

6. Typical value is measured by using thermally conductive grease of $\lambda=0.9$ W/(m·K).

7. Base plate (mounting side) flatness measurement points (X, Y) are as follows of the following figure.

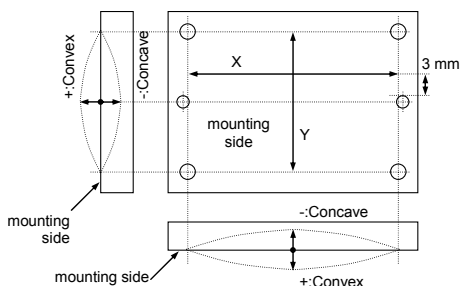

RECOMMENDED OPERATING CONDITIONS

Symbol	Item	Conditions	Limits			Unit
			Min.	Typ.	Max.	
V_{CC}	(DC) Supply voltage	Applied across C1-E2	-	600	850	V
V_{GEon}	Gate (-emitter drive) voltage	Applied across G1-Es1/G2-Es2	13.5	15.0	16.5	V
R_G	External gate resistance	Per switch	0	-	7.5	Ω

< IGBT MODULES >
CM600DY-24S
 HIGH POWER SWITCHING USE
 INSULATED TYPE

CHIP LOCATION (Top view)

Dimension in mm, tolerance: ± 1 mm

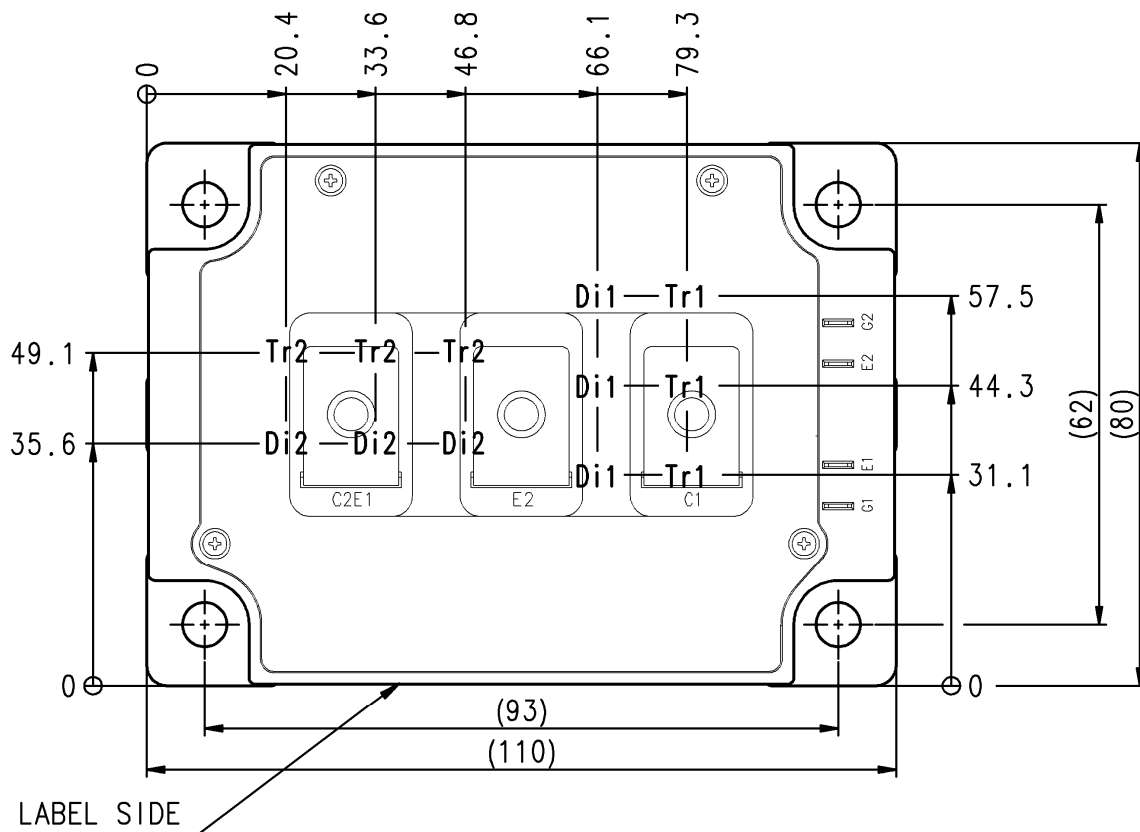

Tr1/Tr2: IGBT, Di1/Di2: FWDi

TEST CIRCUIT

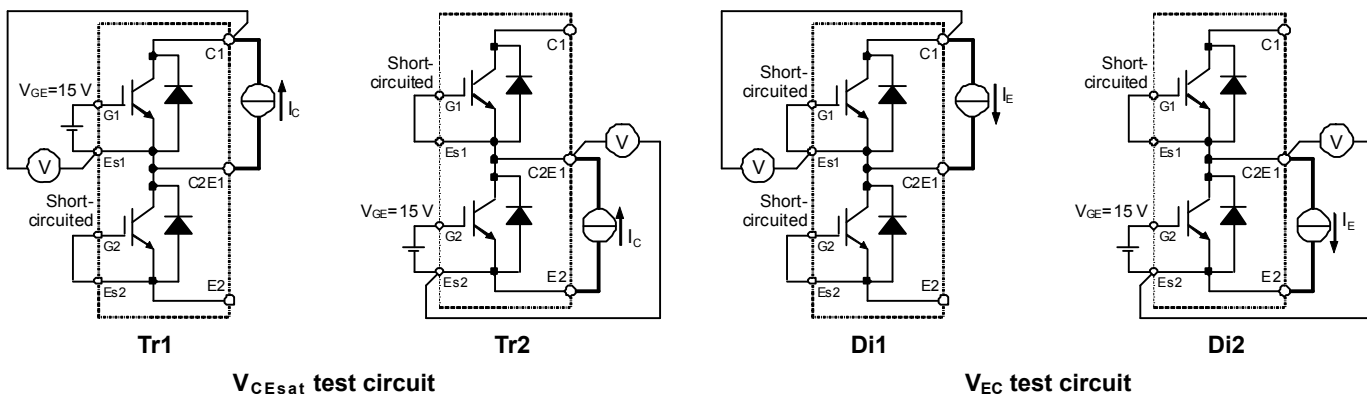

< IGBT MODULES >
CM600DY-24S
 HIGH POWER SWITCHING USE
 INSULATED TYPE

TEST CIRCUIT AND WAVEFORMS

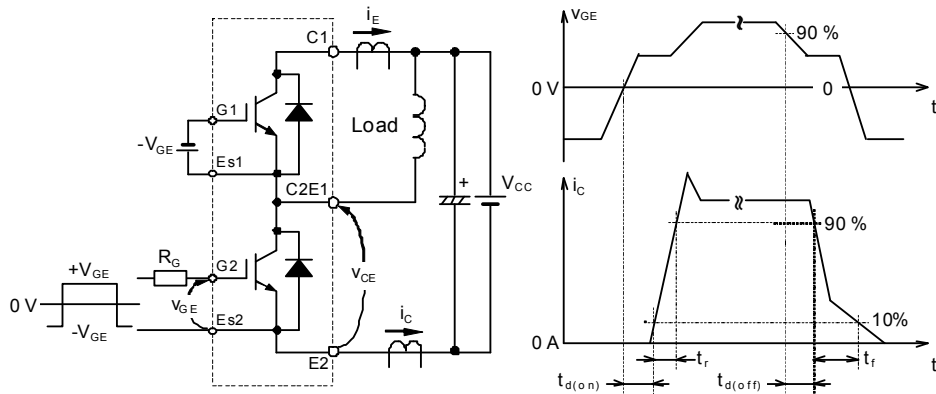

Switching characteristics test circuit and waveforms

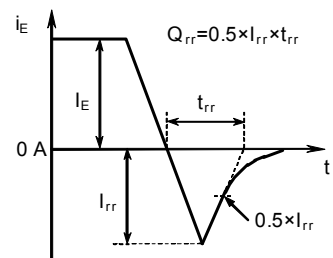

t_{rr}, Q_{rr} test waveform

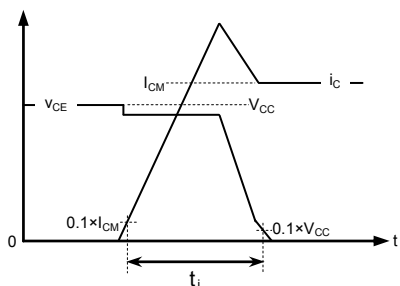

IGBT Turn-on switching energy

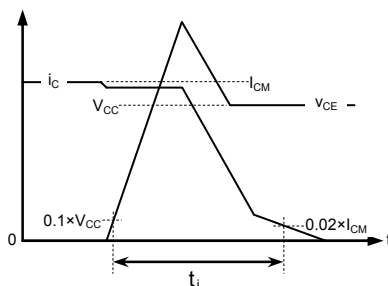

IGBT Turn-off switching energy

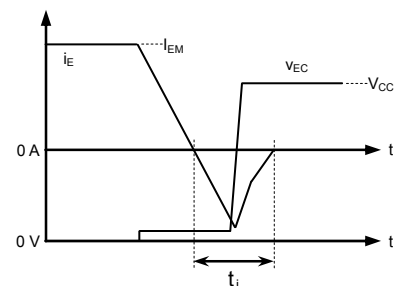

FWDI Reverse recovery energy

Turn-on / Turn-off switching energy and Reverse recovery energy test waveforms (Integral time instruction drawing)

< IGBT MODULES >
CM600DY-24S
 HIGH POWER SWITCHING USE
 INSULATED TYPE

PERFORMANCE CURVES

OUTPUT CHARACTERISTICS
(TYPICAL)

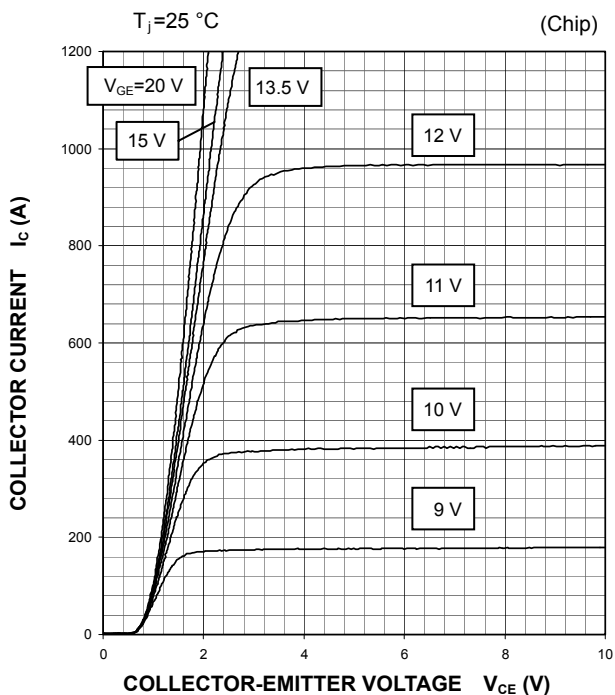

COLLECTOR-EMITTER SATURATION
VOLTAGE CHARACTERISTICS
(TYPICAL)

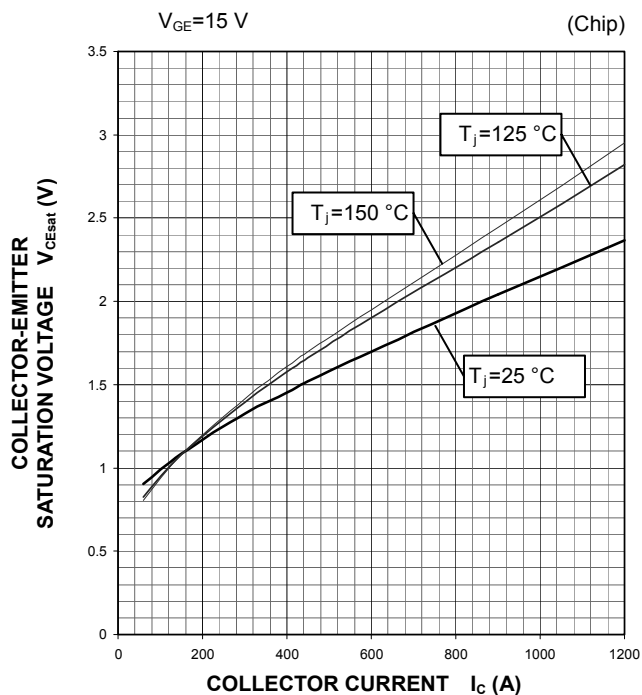

COLLECTOR-EMITTER SATURATION
VOLTAGE CHARACTERISTICS
(TYPICAL)

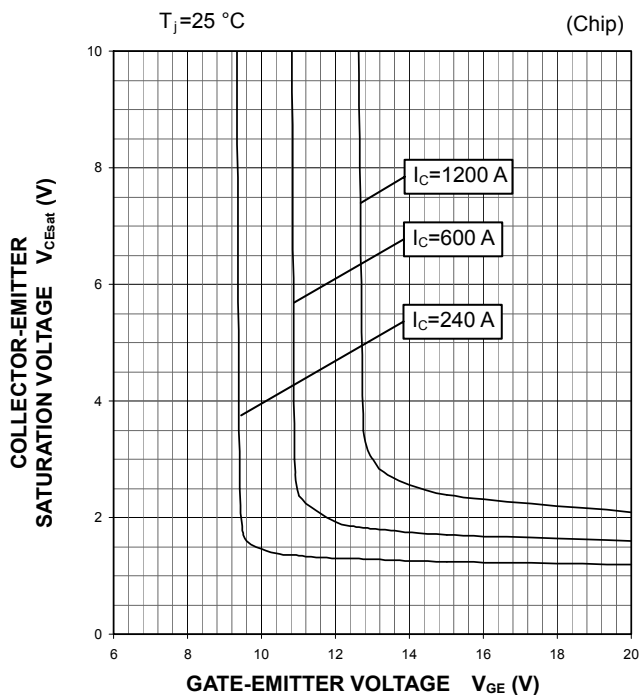

FREE WHEELING DIODE
FORWARD CHARACTERISTICS
(TYPICAL)

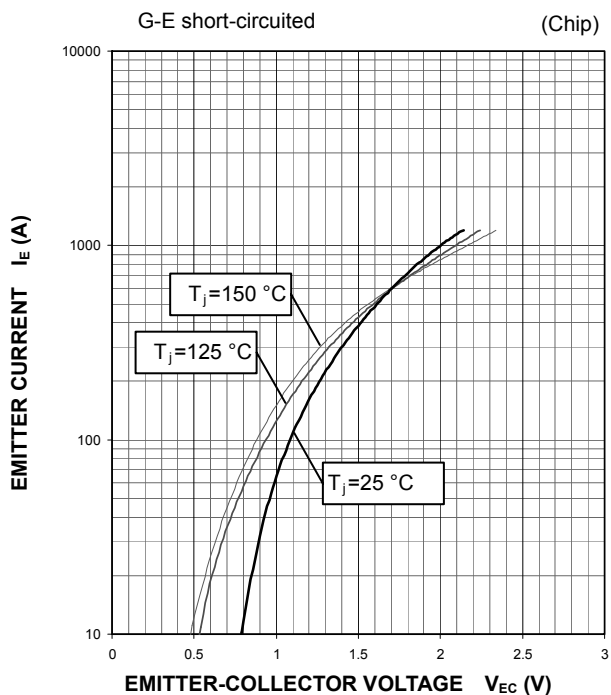

< IGBT MODULES >
CM600DY-24S
 HIGH POWER SWITCHING USE
 INSULATED TYPE

PERFORMANCE CURVES

HALF-BRIDGE SWITCHING CHARACTERISTICS (TYPICAL)

$V_{CC}=600\text{ V}$, $V_{GE}=\pm 15\text{ V}$, $R_G=0\ \Omega$, INDUCTIVE LOAD
 —: $T_j=150\text{ }^\circ\text{C}$, - - - -: $T_j=125\text{ }^\circ\text{C}$

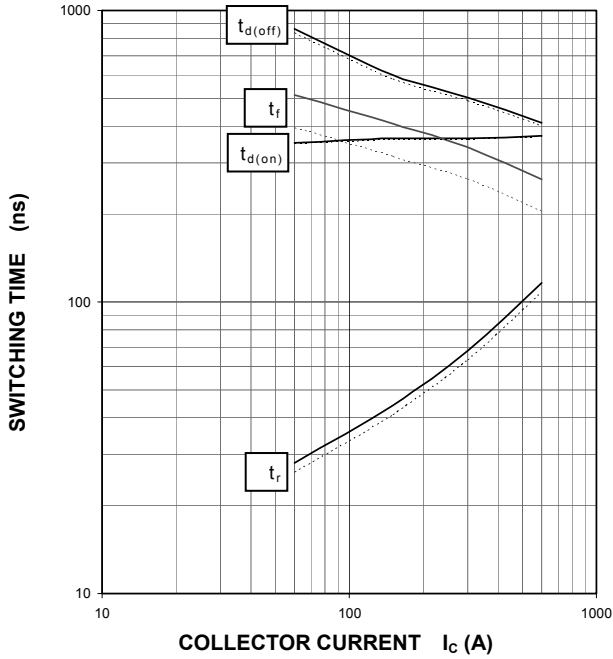

HALF-BRIDGE SWITCHING CHARACTERISTICS (TYPICAL)

$V_{CC}=600\text{ V}$, $I_C=600\text{ A}$, $V_{GE}=\pm 15\text{ V}$, INDUCTIVE LOAD
 —: $T_j=150\text{ }^\circ\text{C}$, - - - -: $T_j=125\text{ }^\circ\text{C}$

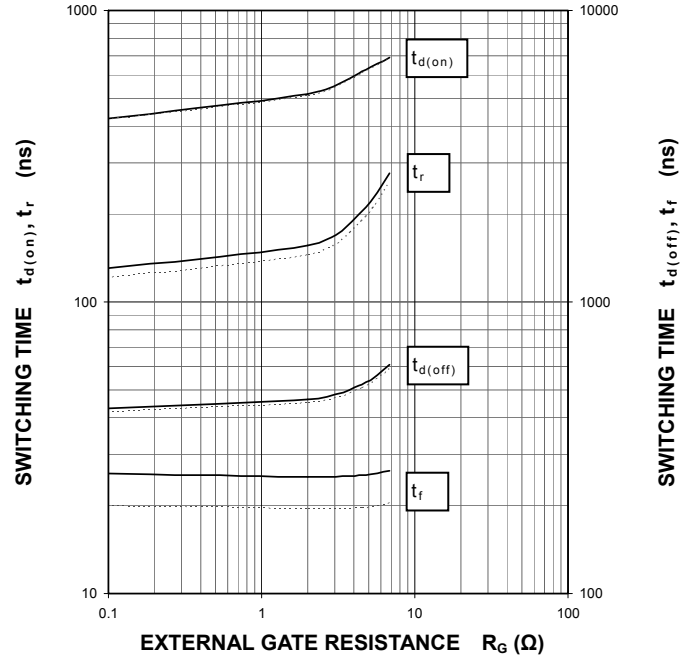

HALF-BRIDGE SWITCHING CHARACTERISTICS (TYPICAL)

$V_{CC}=600\text{ V}$, $V_{GE}=\pm 15\text{ V}$, $R_G=0\ \Omega$,
 INDUCTIVE LOAD, PER PULSE
 —: $T_j=150\text{ }^\circ\text{C}$, - - - -: $T_j=125\text{ }^\circ\text{C}$

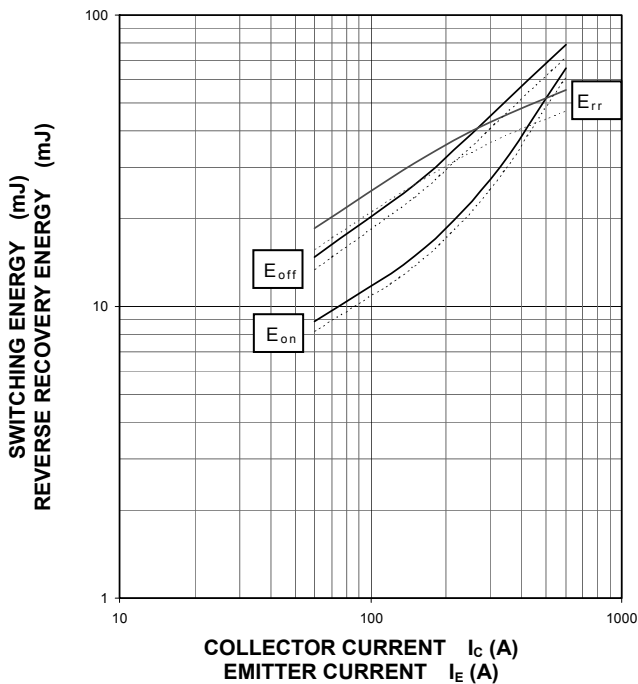

HALF-BRIDGE SWITCHING CHARACTERISTICS (TYPICAL)

$V_{CC}=600\text{ V}$, $I_C/I_E=600\text{ A}$, $V_{GE}=\pm 15\text{ V}$,
 INDUCTIVE LOAD, PER PULSE
 —: $T_j=150\text{ }^\circ\text{C}$, - - - -: $T_j=125\text{ }^\circ\text{C}$

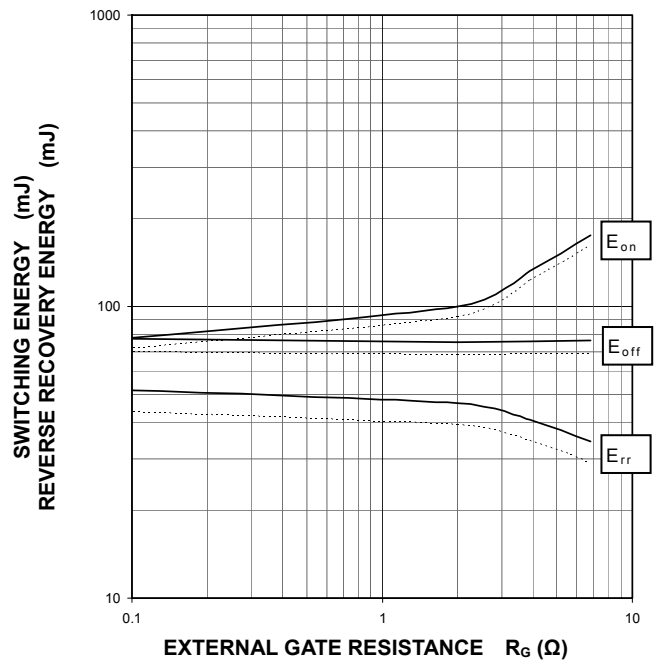

< IGBT MODULES >
CM600DY-24S
 HIGH POWER SWITCHING USE
 INSULATED TYPE

PERFORMANCE CURVES

CAPACITANCE CHARACTERISTICS (TYPICAL)

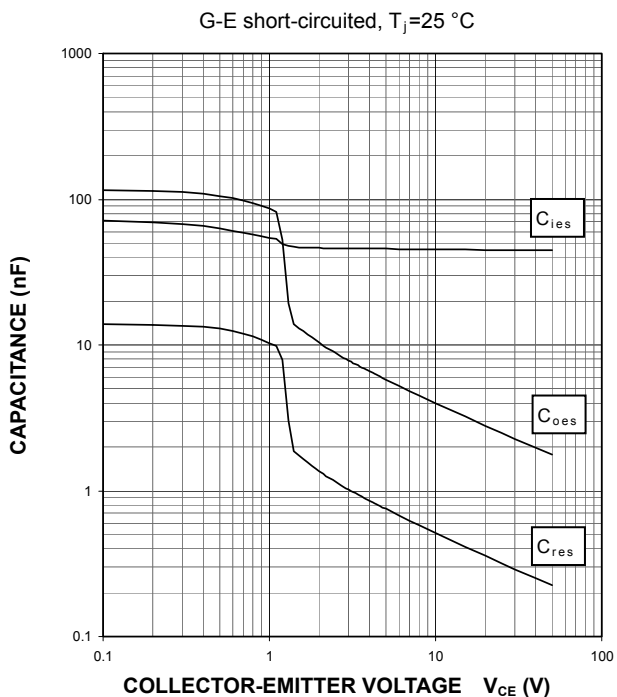

FREE WHEELING DIODE REVERSE RECOVERY CHARACTERISTICS (TYPICAL)

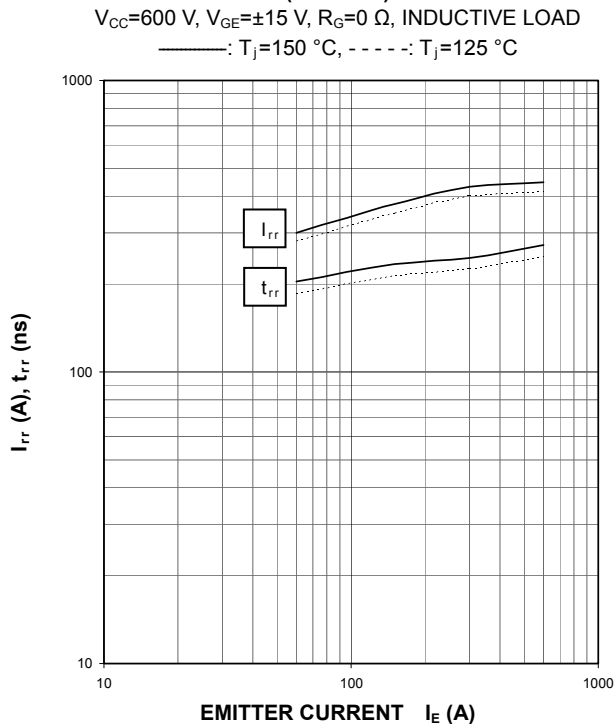

GATE CHARGE CHARACTERISTICS (TYPICAL)

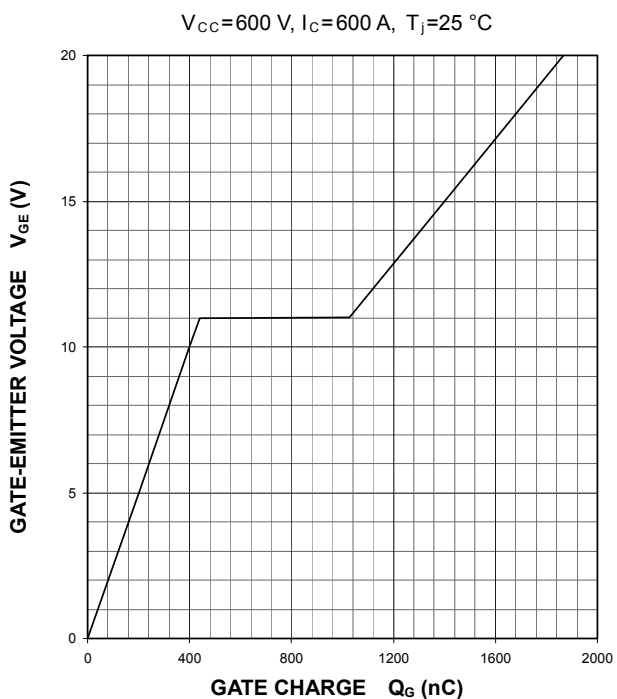

TRANSIENT THERMAL IMPEDANCE CHARACTERISTICS (MAXIMUM)

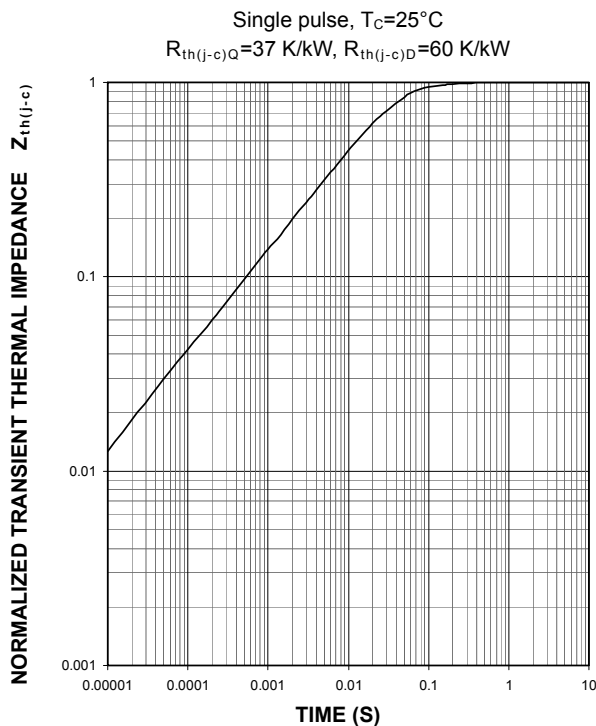

Keep safety first in your circuit designs!

Mitsubishi Electric Corporation puts the maximum effort into making semiconductor products better and more reliable, but there is always the possibility that trouble may occur with them. Trouble with semiconductors may lead to personal injury, fire or property damage. Remember to give due consideration to safety when making your circuit designs, with appropriate measures such as (i) placement of substitutive, auxiliary circuits, (ii) use of non-flammable material or (iii) prevention against any malfunction or mishap.

Notes regarding these materials

- These materials are intended as a reference to assist our customers in the selection of the Mitsubishi semiconductor product best suited to the customer's application; they do not convey any license under any intellectual property rights, or any other rights, belonging to Mitsubishi Electric Corporation or a third party.
- Mitsubishi Electric Corporation assumes no responsibility for any damage, or infringement of any third-party's rights, originating in the use of any product data, diagrams, charts, programs, algorithms, or circuit application examples contained in these materials.
- All information contained in these materials, including product data, diagrams, charts, programs and algorithms represents information on products at the time of publication of these materials, and are subject to change by Mitsubishi Electric Corporation without notice due to product improvements or other reasons. It is therefore recommended that customers contact Mitsubishi Electric Corporation or an authorized Mitsubishi Semiconductor product distributor for the latest product information before purchasing a product listed herein.
The information described here may contain technical inaccuracies or typographical errors. Mitsubishi Electric Corporation assumes no responsibility for any damage, liability, or other loss rising from these inaccuracies or errors.
Please also pay attention to information published by Mitsubishi Electric Corporation by various means, including the Mitsubishi Semiconductor home page (www.MitsubishiElectric.com/semiconductors/).
- When using any or all of the information contained in these materials, including product data, diagrams, charts, programs, and algorithms, please be sure to evaluate all information as a total system before making a final decision on the applicability of the information and products. Mitsubishi Electric Corporation assumes no responsibility for any damage, liability or other loss resulting from the information contained herein.
- Mitsubishi Electric Corporation semiconductors are not designed or manufactured for use in a device or system that is used under circumstances in which human life is potentially at stake. Please contact Mitsubishi Electric Corporation or an authorized Mitsubishi Semiconductor product distributor when considering the use of a product contained herein for any specific purposes, such as apparatus or systems for transportation, vehicular, medical, aerospace, nuclear, or undersea repeater use.
- The prior written approval of Mitsubishi Electric Corporation is necessary to reprint or reproduce in whole or in part these materials.
- If these products or technologies are subject to the Japanese export control restrictions, they must be exported under a license from the Japanese government and cannot be imported into a country other than the approved destination.
Any diversion or reexport contrary to the export control laws and regulations of Japan and/or the country of destination is prohibited.
- Please contact Mitsubishi Electric Corporation or an authorized Mitsubishi Semiconductor product distributor for further details on these materials or the products contained therein.

mitsubishi

<IGBT モジュール>

CM600DY-24S

大電カスイッチング用
絶縁形



2素子入

コレクタ電流 I_C 600 A
 コレクタ・エミッタ間電圧 V_{CES} 1200 V
 最大接合温度 T_{jmax} 175 °C

- フラットベース形
- 銅ベース板
- RoHS 指令対応
- UL Recognized under UL1557, File E323585

用途

インバータ装置, サーボアンプ, 電源装置 など

外形及び接続図

単位 : mm

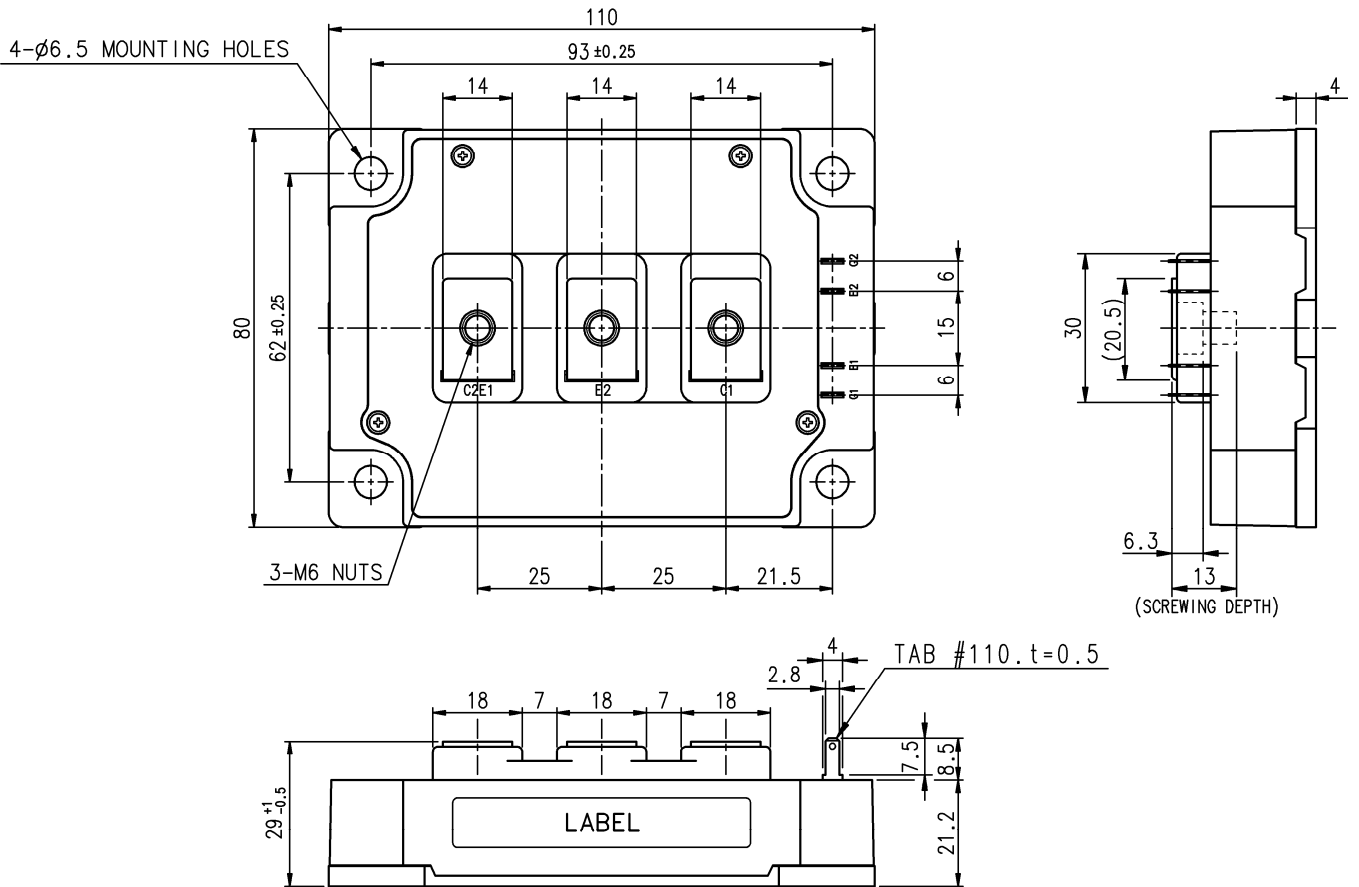

Tolerance otherwise specified

Division of Dimension	Tolerance
0.5 to 3	±0.2
over 3 to 6	±0.3
over 6 to 30	±0.5
over 30 to 120	±0.8
over 120 to 400	±1.2

接続図

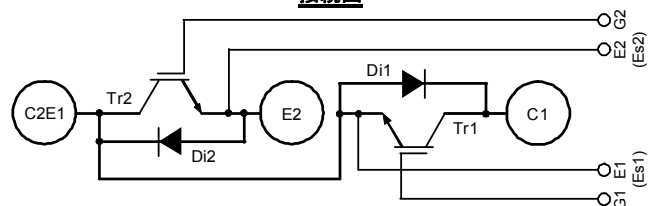

CM600DY-24S

大電力スイッチング用

絶縁形

絶対最大定格 (指定のない場合, $T_j=25\text{ }^\circ\text{C}$)

記号	項目	条件	定格値	単位
V_{CES}	コレクタ・エミッタ間電圧	G-E 間短絡	1200	V
V_{GES}	ゲート・エミッタ間電圧	C-E 間短絡	± 20	V
I_C	コレクタ電流	直流, $T_C=112\text{ }^\circ\text{C}$ (注2, 4)	600	A
I_{CRM}		パルス, 繰返し (注3)	1200	
P_{tot}	コレクタ損失	$T_C=25\text{ }^\circ\text{C}$ (注2, 4)	4050	W
I_E (注1)	エミッタ電流	(注2)	600	A
I_{ERM} (注1)		パルス, 繰返し (注3)	1200	
V_{isol}	絶縁耐電圧	全端子・ベース板間, 実効値, $f=60\text{ Hz}$, AC 1 分間	2500	V
T_{jmax}	最大接合温度	瞬時動作 (過負荷等)	175	$^\circ\text{C}$
T_{cmax}	最大ケース温度	(注4)	125	
T_{jopr}	動作接合温度	連続動作	-40 ~ +150	$^\circ\text{C}$
T_{stg}	保存温度	-	-40 ~ +125	

電気的特性 (指定のない場合, $T_j=25\text{ }^\circ\text{C}$)

記号	項目	条件	規格値			単位		
			最小	標準	最大			
I_{CES}	コレクタ・エミッタ間遮断電流	$V_{CE}=V_{CES}$, G-E 間短絡	-	-	1.0	mA		
I_{GES}	ゲート・エミッタ間漏れ電流	$V_{GE}=V_{GES}$, C-E 間短絡	-	-	0.5	μA		
$V_{GE(th)}$	ゲート・エミッタ間しきい値電圧	$I_C=60\text{ mA}$, $V_{CE}=10\text{ V}$	5.4	6.0	6.6	V		
V_{CEsat}	コレクタ・エミッタ間飽和電圧	$I_C=600\text{ A}$ (注5), $V_{GE}=15\text{ V}$ 端子	$T_j=25\text{ }^\circ\text{C}$	-	1.85	2.25	V	
			$T_j=125\text{ }^\circ\text{C}$	-	2.05	-		
			$T_j=150\text{ }^\circ\text{C}$	-	2.10	-		
		チップ	$I_C=600\text{ A}$ (注5), $V_{GE}=15\text{ V}$	$T_j=25\text{ }^\circ\text{C}$	-	1.70	2.15	V
				$T_j=125\text{ }^\circ\text{C}$	-	1.90	-	
				$T_j=150\text{ }^\circ\text{C}$	-	1.95	-	
C_{ies}	入力容量	$V_{CE}=10\text{ V}$, G-E 間短絡	-	-	60	nF		
C_{oes}	出力容量		-	-	12			
C_{res}	帰還容量		-	-	1.0			
Q_G	ゲート電荷量	$V_{CC}=600\text{ V}$, $I_C=600\text{ A}$, $V_{GE}=15\text{ V}$	-	1400	-	nC		
$t_{d(on)}$	ターンオン遅れ時間	$V_{CC}=600\text{ V}$, $I_C=600\text{ A}$, $V_{GE}=\pm 15\text{ V}$, $R_G=0\text{ }\Omega$, 誘導負荷	-	-	800	ns		
t_r	上昇時間		-	-	200			
$t_{d(off)}$	ターンオフ遅れ時間		-	-	600			
t_f	下降時間		-	-	300			
V_{EC} (注1)	エミッタ・コレクタ間電圧	端子	$I_E=600\text{ A}$ (注5), G-E 間短絡, $T_j=25\text{ }^\circ\text{C}$	-	1.80	2.25	V	
			$T_j=125\text{ }^\circ\text{C}$	-	1.80	-		
			$T_j=150\text{ }^\circ\text{C}$	-	1.80	-		
		チップ	$I_E=600\text{ A}$ (注5), G-E 間短絡, $T_j=25\text{ }^\circ\text{C}$	$T_j=25\text{ }^\circ\text{C}$	-	1.70	2.15	V
				$T_j=125\text{ }^\circ\text{C}$	-	1.70	-	
				$T_j=150\text{ }^\circ\text{C}$	-	1.70	-	
t_{rr} (注1)	逆回復時間	$V_{CC}=600\text{ V}$, $I_E=600\text{ A}$, $V_{GE}=\pm 15\text{ V}$,	-	-	300	ns		
Q_{rr} (注1)	逆回復電荷	$R_G=0\text{ }\Omega$, 誘導負荷	-	32	-	μC		
E_{on}	ターンオンスイッチング損失	$V_{CC}=600\text{ V}$, $I_C=I_E=600\text{ A}$,	-	65.9	-	mJ		
E_{off}	ターンオフスイッチング損失	$V_{GE}=\pm 15\text{ V}$, $R_G=0\text{ }\Omega$, $T_j=150\text{ }^\circ\text{C}$,	-	79.1	-			
E_{rr} (注1)	逆回復損失	誘導負荷, 1パルスあたり	-	55.2	-	mJ		
r_g	内部ゲート抵抗	1素子あたり	-	3.3	-	Ω		

CM600DY-24S

大電力スイッチング用

絶縁形

熱的特性

記号	項目	条件	規格値			単位
			最小	標準	最大	
$R_{th(j-c)Q}$	熱抵抗 (注2)	接合・ケース間, IGBT 1 素子あたり	-	-	37	K/kW
$R_{th(j-c)D}$		接合・ケース間, FWDi 1 素子あたり	-	-	60	
$R_{th(c-s)}$	接触熱抵抗 (注2)	ケース・ヒートシンク間, 1/2 モジュールあたり, 熱伝導性グリス塗布 (注6)	-	18	-	K/kW

機械的定格及び特性

記号	項目	条件	規格値			単位
			最小	標準	最大	
M_t	締付けトルク	主端子 M 6 ネジ	3.5	4.0	4.5	N·m
M_s		取付け M 6 ネジ	3.5	4.0	4.5	
m	質量	-	-	580	-	g
e_c	ベース板平面度	X, Y 各中心線上 (注7)	-100	-	+100	μm

- 注 1. フリーホイールダイオード (FWDi) の定格又は特性を示します。
2. ケース温度 (T_C) 及びヒートシンク温度 (T_S) の定義点は、チップ直下におけるベース板及びヒートシンクの表面です。チップ中心位置は、チップ配置図のとおりです。
3. パルス幅及び繰返し率は、素子の温度上昇が、最大接合温度 ($T_{jmax}=150\text{ }^\circ\text{C}$) を越えない値とします。
4. 接合温度は、最大接合温度 ($T_{jmax}=150\text{ }^\circ\text{C}$) 以下です。
5. パルス幅及び繰返し率は、素子の温度上昇が無視できる値とします。(試験回路は、「 V_{CESat} 」「 V_{EC} 」試験回路図を参照)
6. 接触熱抵抗の標準値は、熱伝導率 $\lambda=0.9\text{ W/(m}\cdot\text{K)}$ の放熱用グリスを使用したときの値です。
7. ベース板 (取付面) 平面度測定箇所は、下図のとおりです。

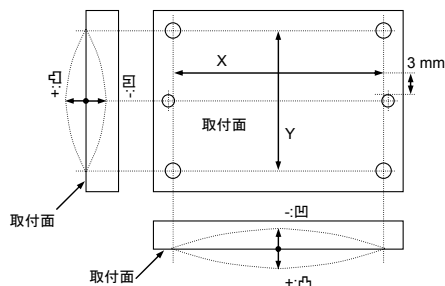

推奨動作条件

記号	項目	条件	規格値			Unit
			最小	標準	最大	
V_{CC}	電源電圧	C1-E2 端子間	-	600	850	V
V_{GEon}	ゲート (駆動) 電圧	G1-Es1/G2-Es2 端子間	13.5	15.0	16.5	
R_G	外部ゲート抵抗	1 素子あたり	0	-	7.5	Ω

CM600DY-24S

大電力スイッチング用
絶縁形

チップ配置図 (Top view)

単位 : mm, 公差 : ±1 mm

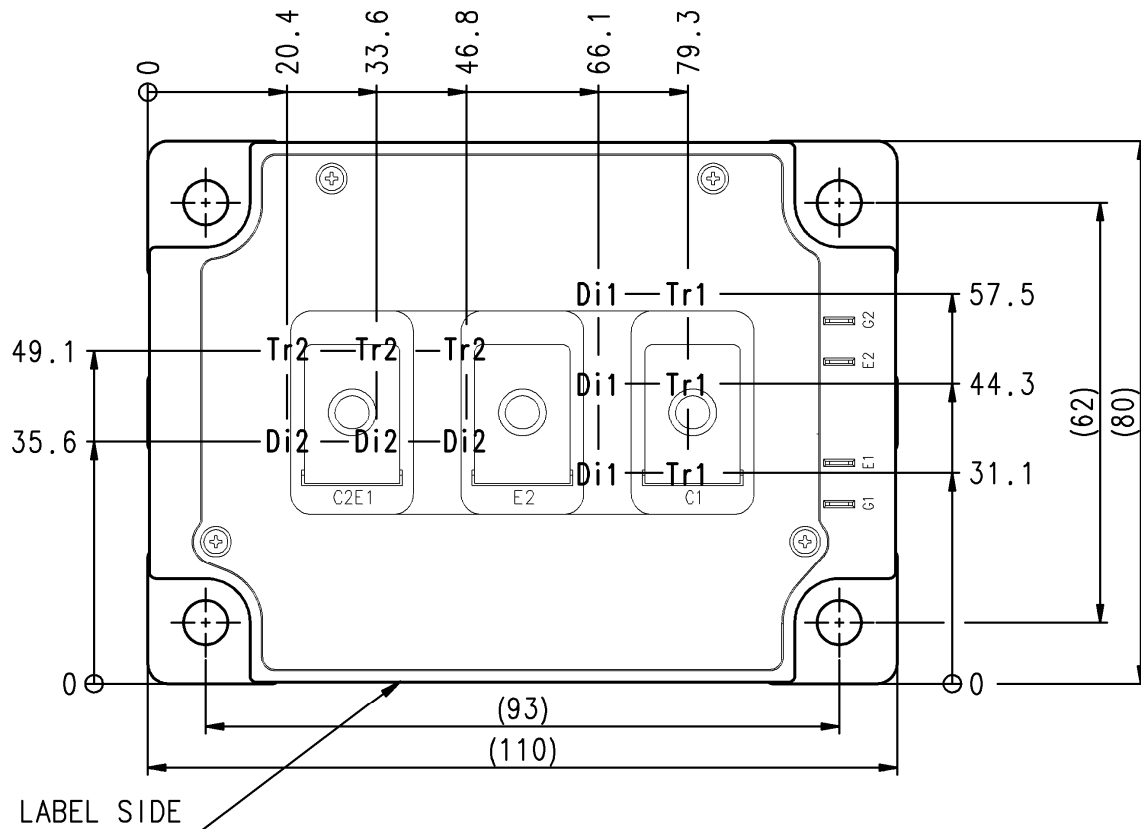

Tr1/Tr2: IGBT, Di1/Di2: FWDi。記号は、それぞれのチップの中心を示します。

試験回路

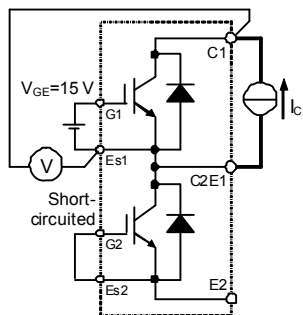

Tr1

V_{CESat} 特性試験回路

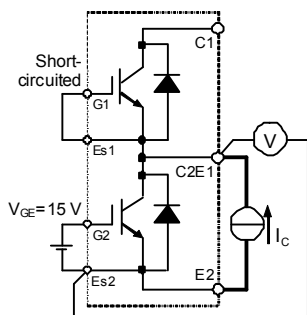

Tr2

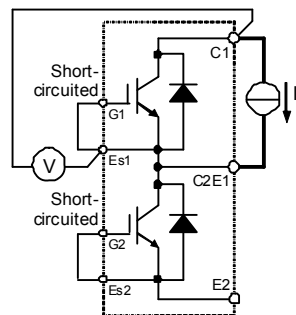

Di1

V_{EC} 特性試験回路

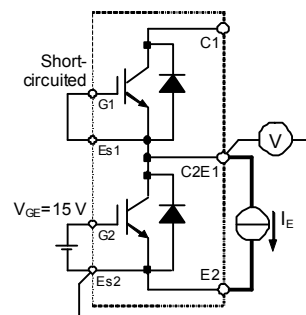

Di2

試験回路及び試験波形

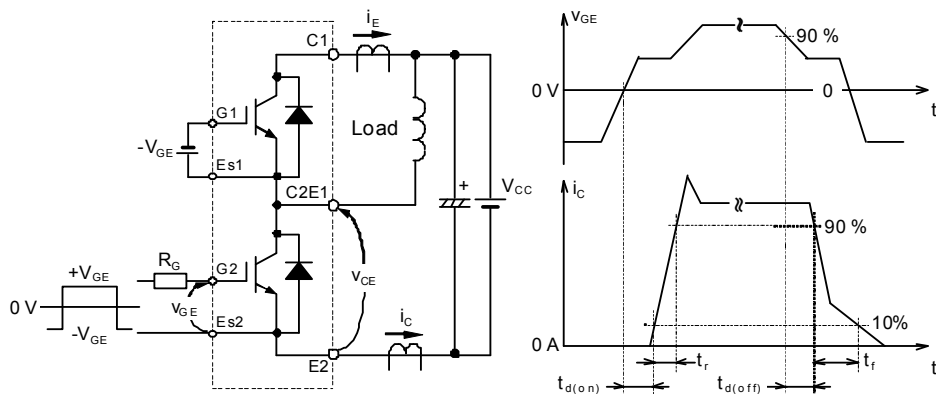

スイッチング特性試験回路及び試験波形

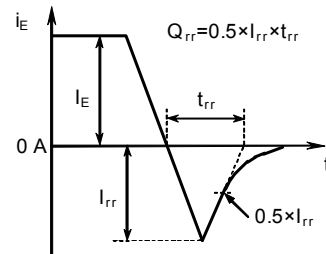

逆回復特性試験波形

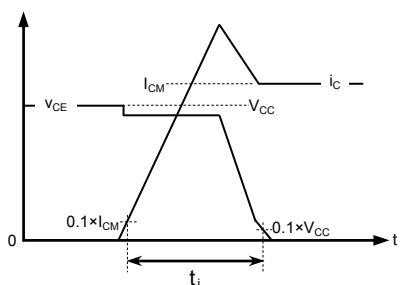

IGBT ターンオンスイッチング損失

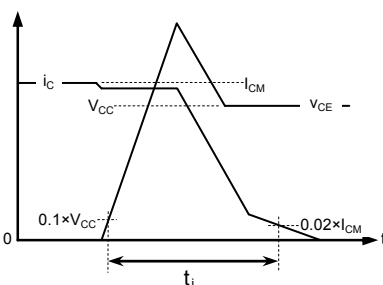

IGBT ターンオフスイッチング損失

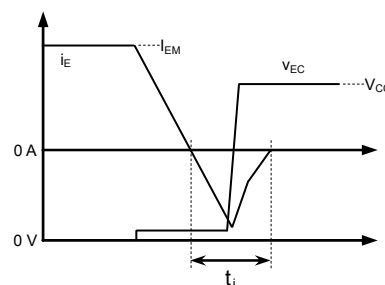

FWDi 逆回復損失

ターンオン / ターンオフスイッチング損失及び逆回復損失試験波形 (積分時間説明図)

CM600DY-24S

大電力スイッチング用
絶縁形

特性図

出力特性
(代表例)

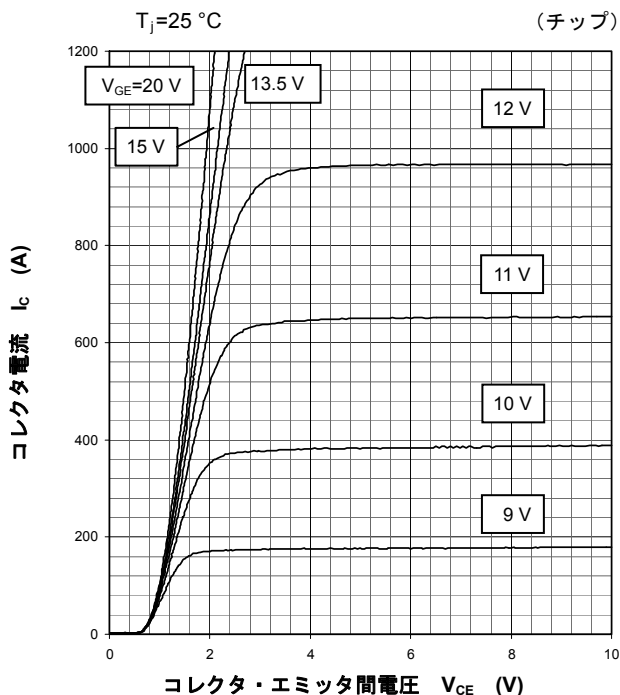

コレクタ・エミッタ間飽和電圧特性
(代表例)

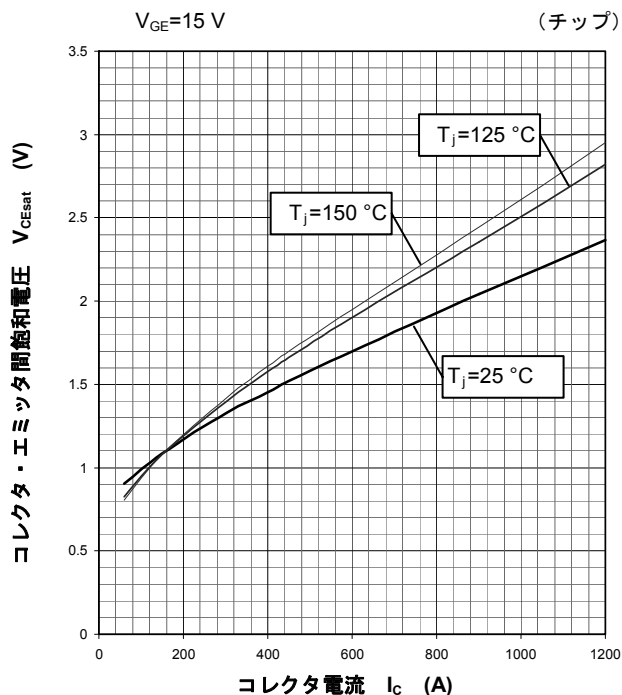

コレクタ・エミッタ間飽和電圧特性
(代表例)

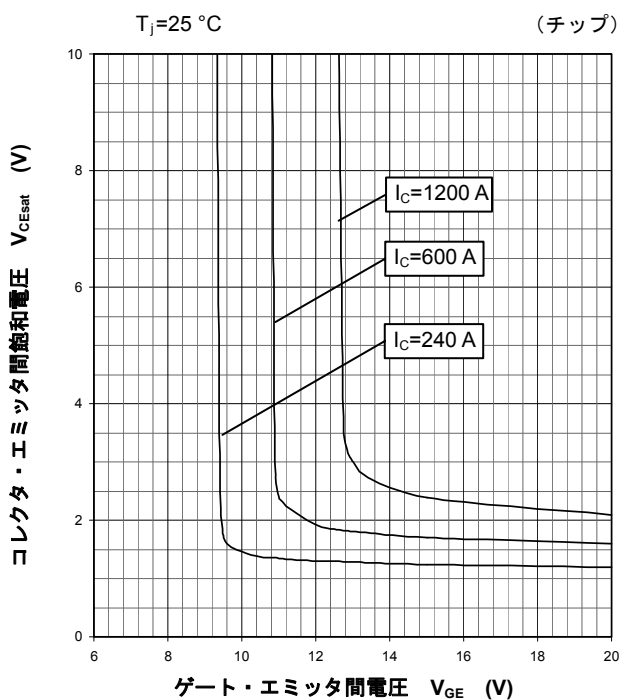

フリーホイールダイオード順特性
(代表例)

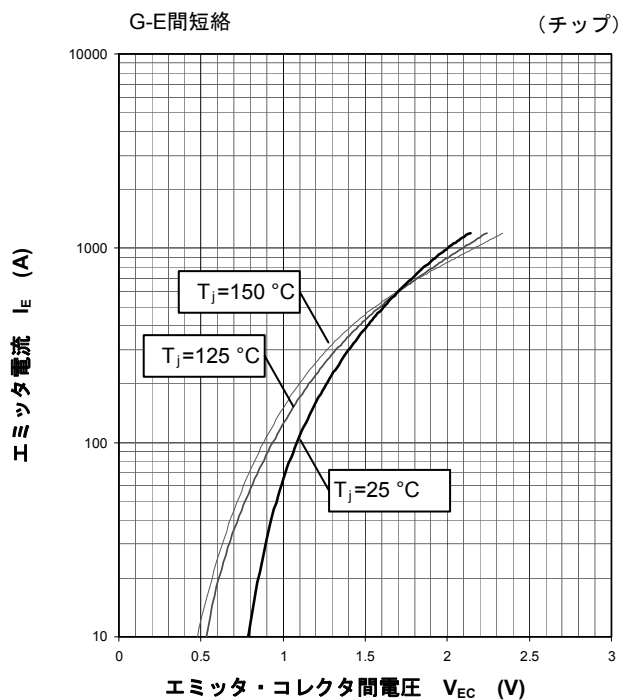

CM600DY-24S

大電力スイッチング用
絶縁形

特性図

スイッチング時間特性
(代表例)

$V_{CC}=600\text{ V}$, $V_{GE}=\pm 15\text{ V}$, $R_G=0\ \Omega$, 誘導負荷
——: $T_j=150\text{ }^\circ\text{C}$, - - - -: $T_j=125\text{ }^\circ\text{C}$

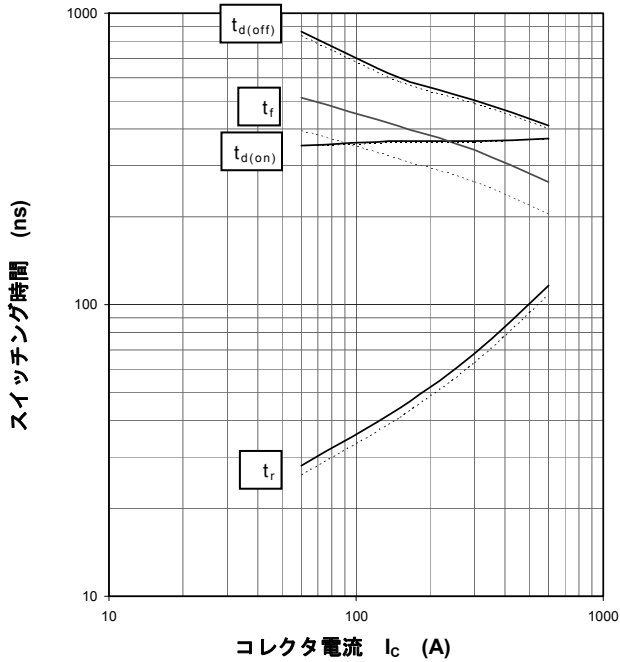

スイッチング時間特性
(代表例)

$V_{CC}=600\text{ V}$, $I_C=600\text{ A}$, $V_{GE}=\pm 15\text{ V}$, 誘導負荷
——: $T_j=150\text{ }^\circ\text{C}$, - - - -: $T_j=125\text{ }^\circ\text{C}$

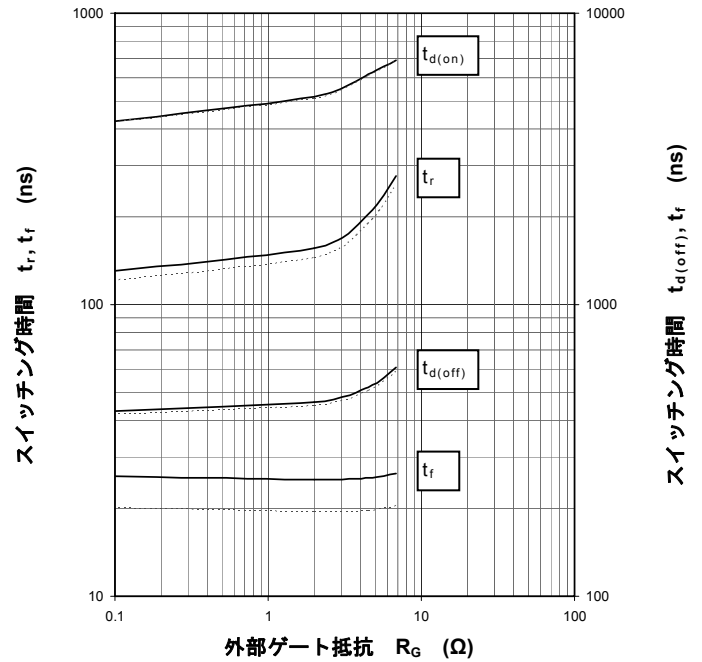

スイッチング損失特性
(代表例)

$V_{CC}=600\text{ V}$, $V_{GE}=\pm 15\text{ V}$, $R_G=0\ \Omega$,
誘導負荷, 1パルスあたり
——: $T_j=150\text{ }^\circ\text{C}$, - - - -: $T_j=125\text{ }^\circ\text{C}$

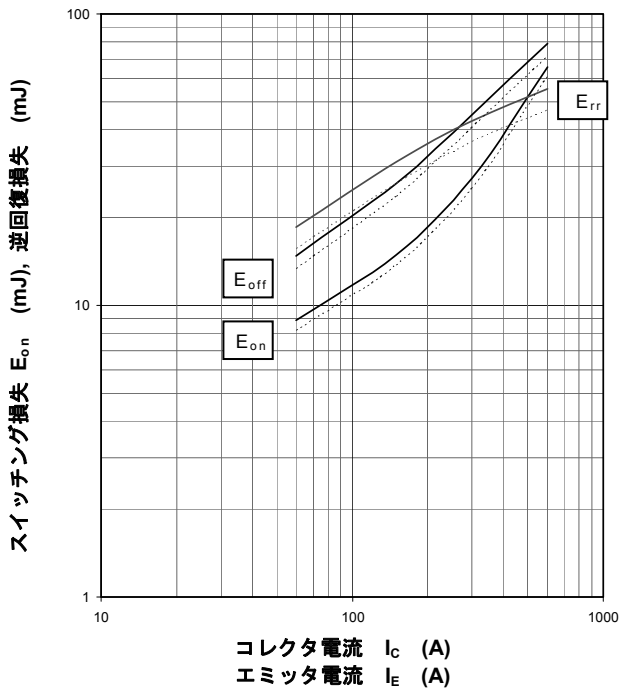

スイッチング損失特性
(代表例)

$V_{CC}=600\text{ V}$, $I_C/I_E=600\text{ A}$, $V_{GE}=\pm 15\text{ V}$,
誘導負荷, 1パルスあたり
——: $T_j=150\text{ }^\circ\text{C}$, - - - -: $T_j=125\text{ }^\circ\text{C}$

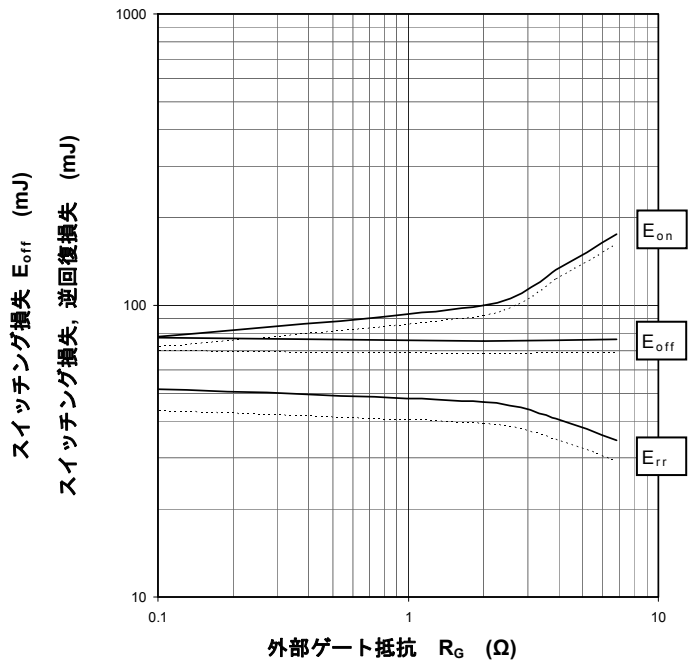

CM600DY-24S

大電力スイッチング用
絶縁形

特性図

容量特性
(代表例)

G-E間短絡, $T_j=25^\circ\text{C}$

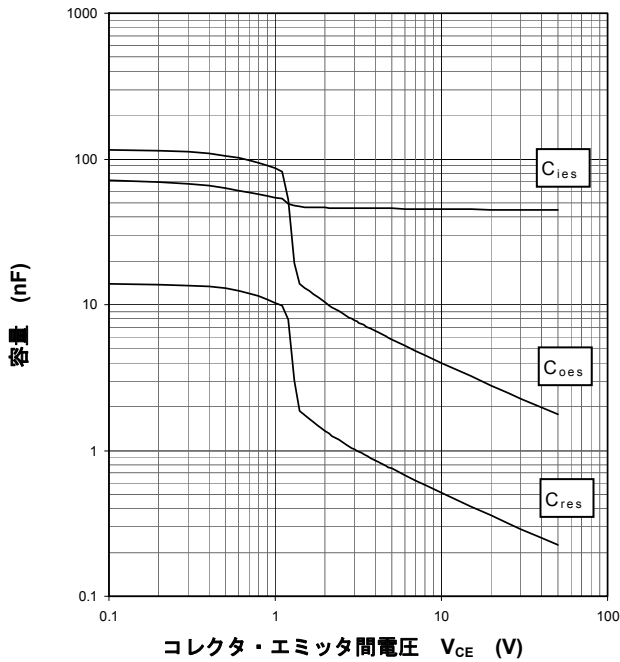

フリーホイールダイオード回復特性
(代表例)

$V_{CC}=600\text{ V}$, $V_{GE}=\pm 15\text{ V}$, $R_G=0\ \Omega$, 誘導負荷
————: $T_j=150^\circ\text{C}$, - - - - -: $T_j=125^\circ\text{C}$

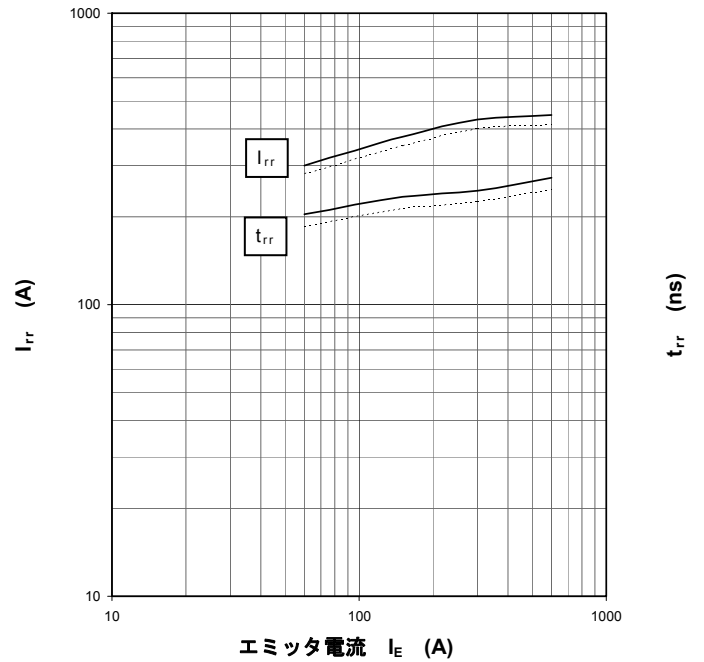

ゲート容量特性
(代表例)

$V_{CC}=600\text{ V}$, $I_C=600\text{ A}$, $T_j=25^\circ\text{C}$

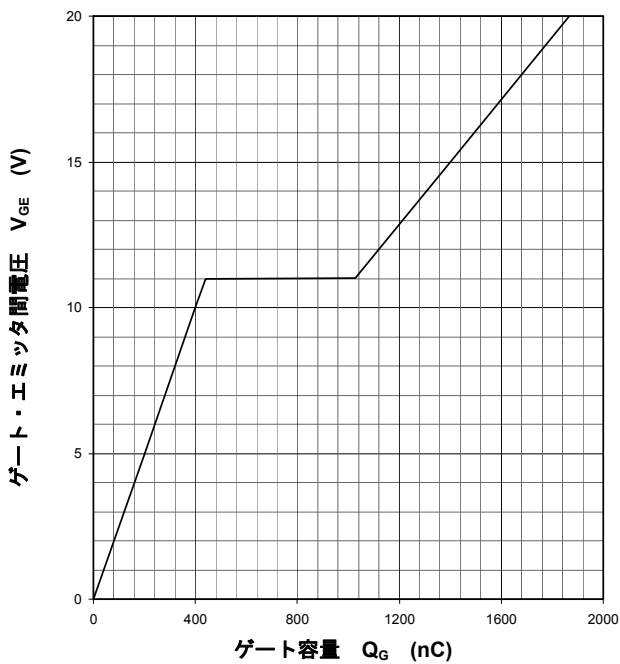

最大過渡熱インピーダンス特性

Single pulse, $T_C=25^\circ\text{C}$
 $R_{th(j-c)Q}=37\text{ K/kW}$, $R_{th(j-c)B}=60\text{ K/kW}$

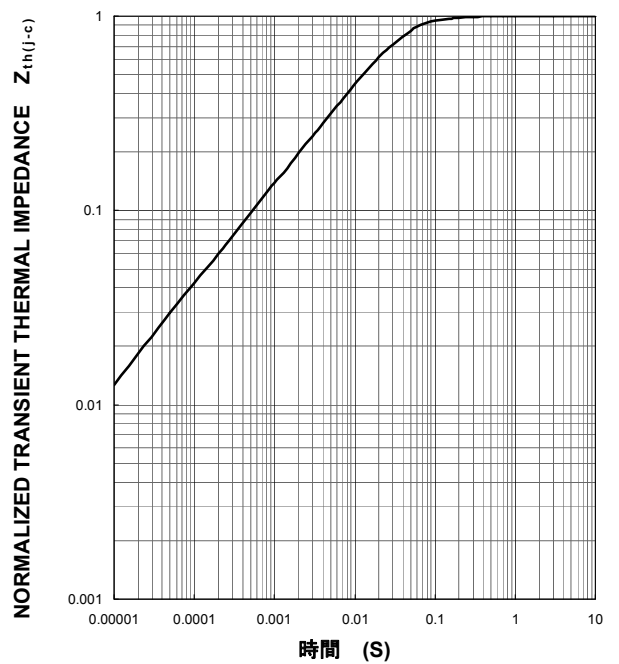

安全設計に関するお願い

弊社は品質、信頼性の向上に努めておりますが、半導体製品は故障が発生したり、誤動作する場合があります。弊社の半導体製品の故障又は誤動作によって結果として、人身事故、火災事故、社会的損害などを生じさせないような安全性を考慮した冗長設計、延焼対策設計、誤動作防止設計などの安全設計に十分ご留意ください。

本資料ご利用に際しての留意事項

- ・本資料は、お客様が用途に応じた適切な三菱半導体製品をご購入いただくための参考資料であり、本資料中に記載の技術情報について三菱電機が所有する知的財産権その他の権利の実施、使用を許諾するものではありません。
- ・本資料に記載の製品データ、図、表、プログラム、アルゴリズムその他応用回路例の使用に起因する損害、第三者所有の権利に対する侵害に関し、三菱電機は責任を負いません。
- ・本資料に記載の製品データ、図、表、プログラム、アルゴリズムその他全ての情報は本資料発行時点のものであり、三菱電機は、予告なしに、本資料に記載した製品又は仕様を変更することがあります。三菱半導体製品のご購入に当たりますは、事前に三菱電機または特約店へ最新の情報をご確認頂きますとともに、三菱電機半導体情報ホームページ (www.MitsubishiElectric.co.jp/semiconductors/) などを通じて公開される情報に常にご注意ください。
- ・本資料に記載した情報は、正確を期すため、慎重に制作したのですが、万一本資料の記述誤りに起因する損害がお客様に生じた場合には、三菱電機はその責任を負いません。
- ・本資料に記載の製品データ、図、表に示す技術的な内容、プログラム及びアルゴリズムを流用する場合は、技術内容、プログラム、アルゴリズム単位で評価するだけでなく、システム全体で十分に評価し、お客様の責任において適用可否を判断してください。三菱電機は、適用可否に対する責任は負いません。
- ・本資料に記載された製品は、人命にかかわるような状況の下で使用される機器あるいはシステムに用いられることを目的として設計、製造されたものではありません。本資料に記載の製品を運輸、移動体用、医療用、航空宇宙用、原子力制御用、海底中継用機器あるいはシステムなど、特殊用途へのご利用をご検討の際は、三菱電機または特約店へご照会ください。
- ・本資料の転載、複製については、文書による三菱電機の事前の承諾が必要です。
- ・本資料に関し詳細についてのお問い合わせ、その他お気づきの点がございましたら三菱電機または特約店までご照会ください。