

**PRELIMINARY**  
 Notice: This is not a final specification.  
 Some parametric limits are subject to change.

MITSUBISHI HVIGBT MODULES  
**CM600HB-90H**

2nd-Version HVIGBT (High Voltage Insulated Gate Bipolar Transistor) Modules

HIGH POWER SWITCHING USE  
**INSULATED TYPE**

**CM600HB-90H**



- IC.....600A
- VCES ..... 4500V
- Insulated Type
- 1-element in a pack

**APPLICATION**

Inverters, Converters, DC choppers, Induction heating, DC to DC converters.

**OUTLINE DRAWING & CIRCUIT DIAGRAM**

Dimensions in mm

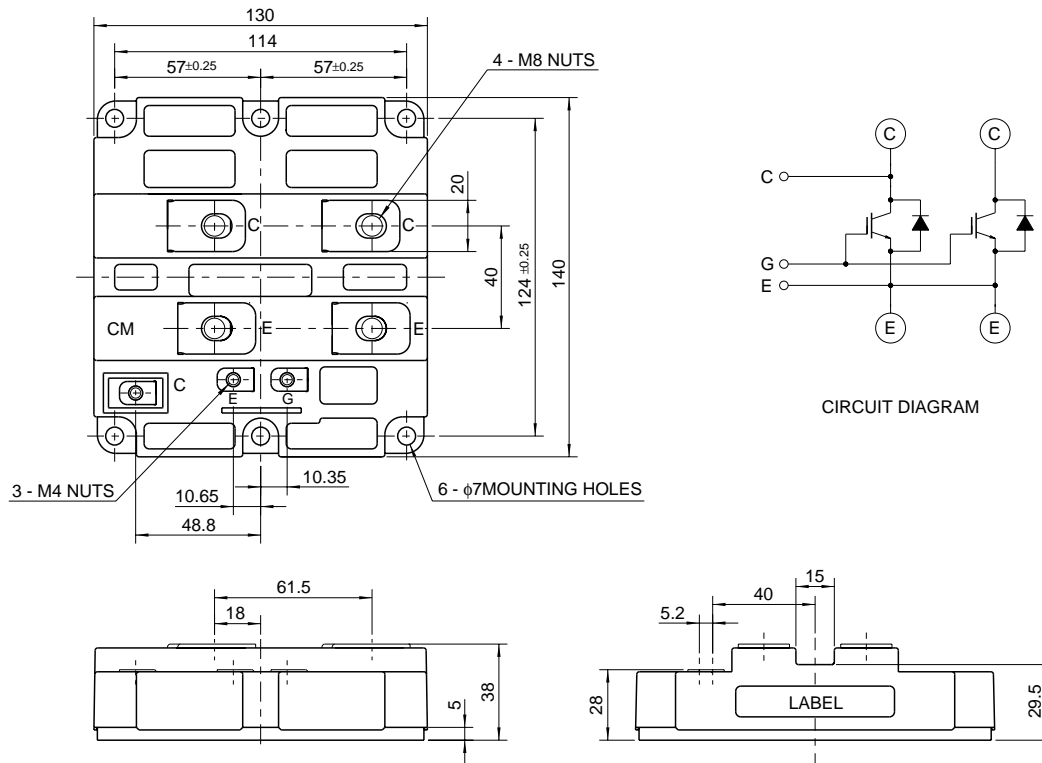

HVIGBT MODULES (High Voltage Insulated Gate Bipolar Transistor Modules)

Mar. 2001

**PRELIMINARY**  
 Notice: This is not a final specification.  
 Some parametric limits are subject to change.

**CM600HB-90H**

**HIGH POWER SWITCHING USE  
 INSULATED TYPE**

2nd-Version HVIGBT (High Voltage Insulated Gate Bipolar Transistor) Modules

**MAXIMUM RATINGS (T<sub>j</sub> = 25°C)**

Symbol	Item	Conditions	Ratings	Unit
V <sub>CEs</sub>	Collector-emitter voltage	V <sub>GE</sub> = 0V	4500	V
V <sub>GES</sub>	Gate-emitter voltage	V <sub>CE</sub> = 0V	±20	V
I <sub>C</sub>	Collector current	T <sub>C</sub> = 25°C	600	A
I <sub>CM</sub>		Pulse (Note 1)	1200	A
I <sub>E</sub> (Note 2)	Emitter current	T <sub>C</sub> = 25°C	600	A
I <sub>EM</sub> (Note 2)		Pulse (Note 1)	1200	A
P <sub>C</sub> (Note 3)	Maximum collector dissipation	T <sub>C</sub> = 25°C, IGBT part	6700	W
T <sub>j</sub>	Junction temperature	—	-40 ~ +125	°C
T <sub>stg</sub>	Storage temperature	—	-40 ~ +125	°C
V <sub>iso</sub>	Isolation voltage	Charged part to base plate, rms, sinusoidal, AC 60Hz 1min.	6000	V
—	Mounting torque	Main terminals screw M8	6.67 ~ 13.00	N·m
		Mounting screw M6	2.84 ~ 6.00	N·m
		Auxiliary terminals screw M4	0.88 ~ 2.00	N·m
—	Mass	Typical value	1.5	kg

**ELECTRICAL CHARACTERISTICS (T<sub>j</sub> = 25°C)**

Symbol	Item	Conditions	Limits			Unit
			Min	Typ	Max	
I <sub>CEs</sub>	Collector cutoff current	V <sub>CE</sub> = V <sub>CEs</sub> , V <sub>GE</sub> = 0V	—	—	12	mA
V <sub>GE(th)</sub>	Gate-emitter threshold voltage	I <sub>C</sub> = 60mA, V <sub>CE</sub> = 10V	4.5	6.0	7.5	V
I <sub>GES</sub>	Gate-leakage current	V <sub>GE</sub> = V <sub>GES</sub> , V <sub>CE</sub> = 0V	—	—	0.5	μA
V <sub>CE(sat)</sub>	Collector-emitter saturation voltage	T <sub>j</sub> = 25°C	—	3.00	3.90	V
		T <sub>j</sub> = 125°C	—	3.30	—	
C <sub>ies</sub>	Input capacitance	V <sub>CE</sub> = 10V	—	108	—	nF
C <sub>oes</sub>	Output capacitance	V <sub>GE</sub> = 0V	—	8.0	—	nF
C <sub>res</sub>	Reverse transfer capacitance	—	—	2.4	—	nF
Q <sub>G</sub>	Total gate charge	V <sub>CC</sub> = 2250V, I <sub>C</sub> = 600A, V <sub>GE</sub> = 15V	—	5.4	—	μC
t <sub>d(on)</sub>	Turn-on delay time	V <sub>CC</sub> = 2250V, I <sub>C</sub> = 600A	—	—	2.40	μs
t <sub>r</sub>	Turn-on rise time	V <sub>GE1</sub> = V <sub>GE2</sub> = 15V	—	—	2.40	μs
t <sub>d(off)</sub>	Turn-off delay time	R <sub>G</sub> = 15Ω	—	—	6.00	μs
t <sub>f</sub>	Turn-off fall time	Resistive load switching operation	—	—	1.20	μs
V <sub>EC</sub> (Note 2)	Emitter-collector voltage	I <sub>E</sub> = 600A, V <sub>GE</sub> = 0V	—	4.00	5.20	V
t <sub>rr</sub> (Note 2)	Reverse recovery time	I <sub>E</sub> = 600A,	—	—	1.80	μs
Q <sub>rr</sub> (Note 2)	Reverse recovery charge	die / dt = -1200A / μs (Note 1)	—	240	—	μC
R <sub>th(j-c)Q</sub>	Thermal resistance	Junction to case, IGBT part	—	—	0.015	K/W
R <sub>th(j-c)R</sub>		Junction to case, FWDi part	—	—	0.030	K/W
R <sub>th(c-f)</sub>	Contact thermal resistance	Case to fin, conductive grease applied	—	0.010	—	K/W

- Note 1. Pulse width and repetition rate should be such that the device junction temp. (T<sub>j</sub>) does not exceed T<sub>jmax</sub> rating.  
 2. I<sub>E</sub>, V<sub>EC</sub>, t<sub>rr</sub>, Q<sub>rr</sub> & die/dt represent characteristics of the anti-parallel, emitter to collector free-wheel diode.  
 3. Junction temperature (T<sub>j</sub>) should not increase beyond 125°C.  
 4. Pulse width and repetition rate should be such as to cause negligible temperature rise.

**PERFORMANCE CURVES**

**OUTPUT CHARACTERISTICS  
 (TYPICAL)**

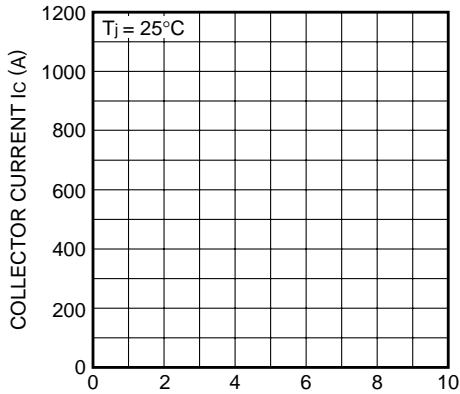

COLLECTOR-EMITTER SATURATION VOLTAGE  $V_{CE(sat)}$  (V)

**TRANSFER CHARACTERISTICS  
 (TYPICAL)**

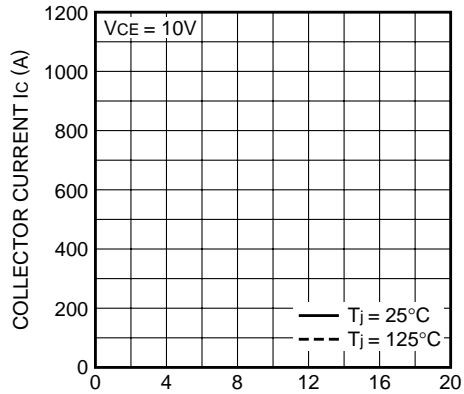

GATE-EMITTER VOLTAGE  $V_{GE}$  (V)

**COLLECTOR-EMITTER SATURATION  
 VOLTAGE CHARACTERISTICS  
 (TYPICAL)**

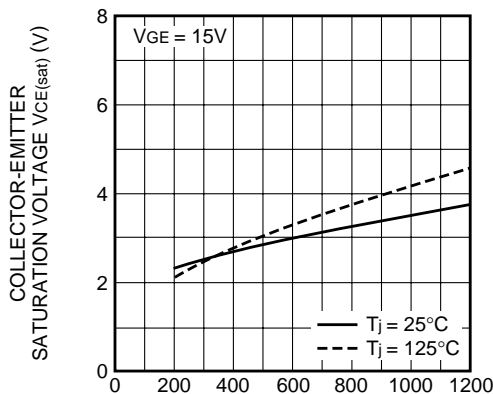

COLLECTOR CURRENT  $I_c$  (A)

**COLLECTOR-EMITTER SATURATION  
 VOLTAGE CHARACTERISTICS  
 (TYPICAL)**

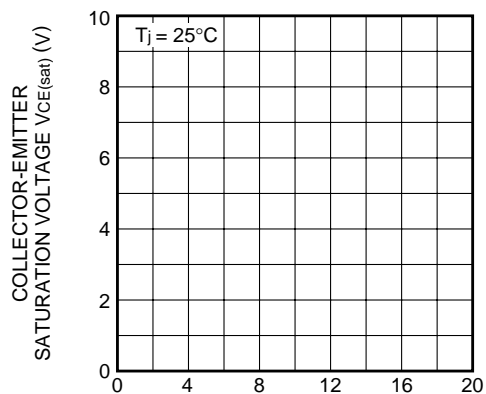

GATE-EMITTER VOLTAGE  $V_{GE}$  (V)

**FREE-WHEEL DIODE  
 FORWARD CHARACTERISTICS  
 (TYPICAL)**

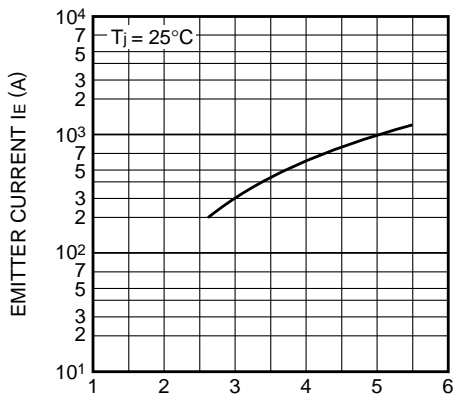

EMITTER-COLLECTOR VOLTAGE  $V_{EC}$  (V)

**CAPACITANCE VS.  $V_{CE}$   
 (TYPICAL)**

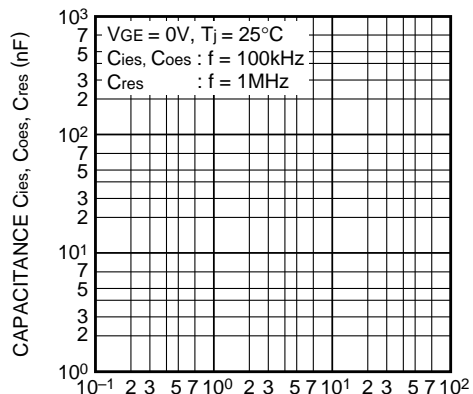

COLLECTOR-EMITTER VOLTAGE  $V_{CE}$  (V)

**PRELIMINARY**  
 Notice: This is not a final specification.  
 Some parametric limits are subject to change.

**CM600HB-90H**

**HIGH POWER SWITCHING USE  
 INSULATED TYPE**

2nd-Version HVIGBT (High Voltage Insulated Gate Bipolar Transistor) Modules

**HALF-BRIDGE  
 SWITCHING CHARACTERISTICS  
 (TYPICAL)**

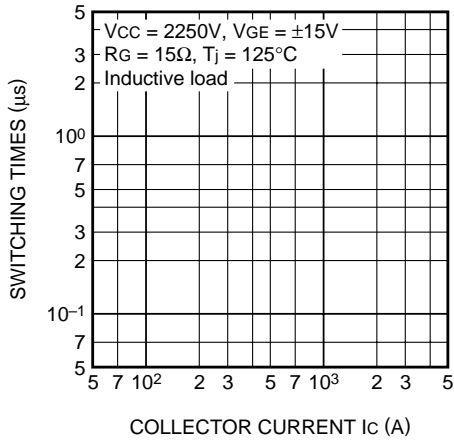

**REVERSE RECOVERY CHARACTERISTICS  
 OF FREE-WHEEL DIODE  
 (TYPICAL)**

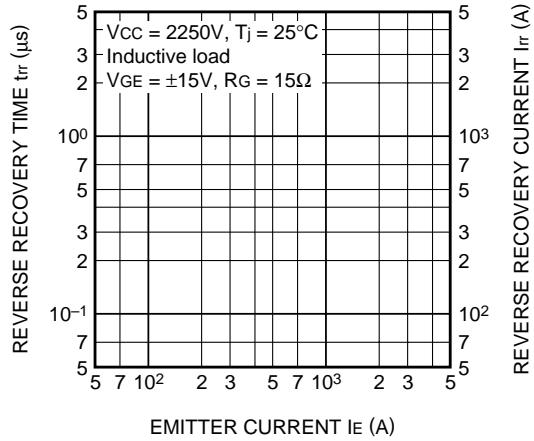

**TRANSIENT THERMAL  
 IMPEDANCE CHARACTERISTICS  
 (IGBT part)**

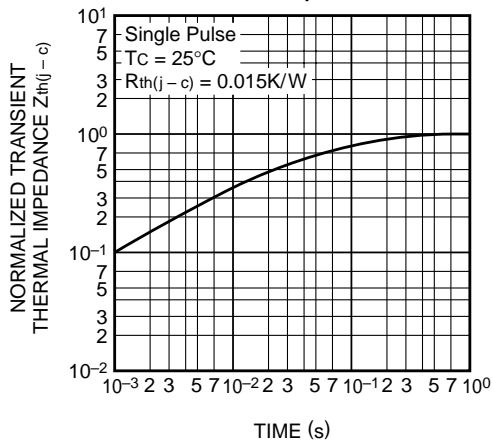

**TRANSIENT THERMAL  
 IMPEDANCE CHARACTERISTICS  
 (FWDi part)**

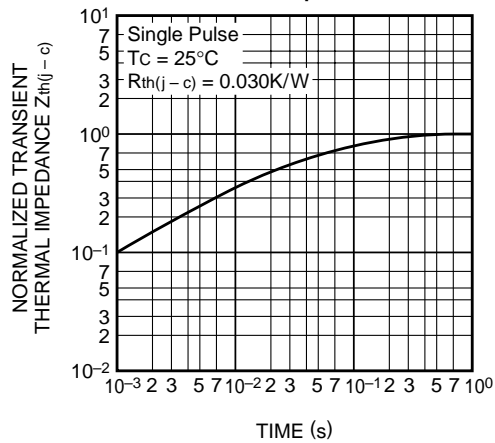

**VGE - GATE CHARGE  
 (TYPICAL)**

