

**MITSUBISHI IGBT MODULES**  
**CM75E3U-12H**  
**HIGH POWER SWITCHING USE**  
**INSULATED TYPE**

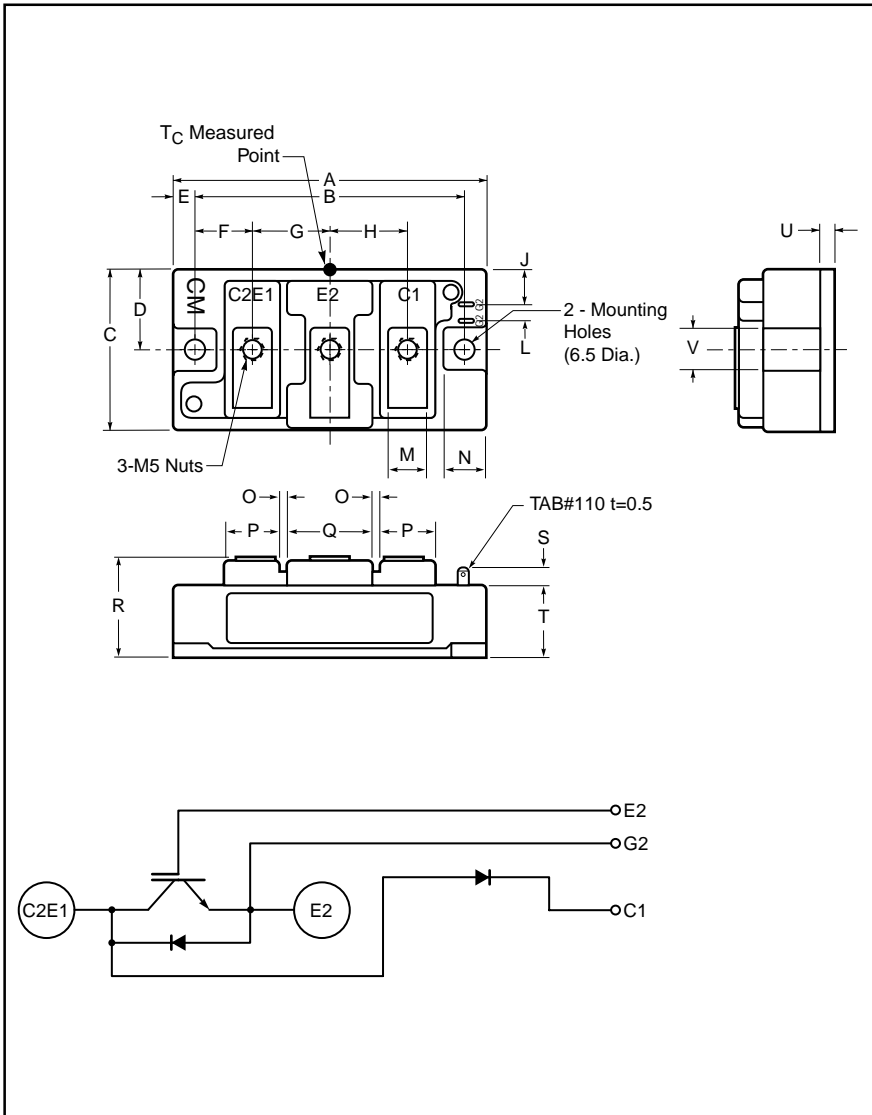

**Description:**

Mitsubishi IGBT Modules are designed for use in switching applications. Each module consists of one IGBT having a reverse-connected super-fast recovery free-wheel diode and an anode-collector connected super-fast recovery free-wheel diode. All components and interconnects are isolated from the heat sinking baseplate, offering simplified system assembly and thermal management.

**Features:**

- Low Drive Power
- Low  $V_{CE(sat)}$
- Discrete Super-Fast Recovery Free-Wheel Diode
- High Frequency Operation
- Isolated Baseplate for Easy Heat Sinking

**Application:**

- Brake

**Ordering Information:**

Example: Select the complete module number you desire from the table - i.e. CM75E3U-12H is a 600V ( $V_{CES}$ ), 75 Ampere IGBT Module.

| Type | Current Rating<br>Amperes | $V_{CES}$<br>Volts (x 50) |
|------|---------------------------|---------------------------|
| CM   | 75                        | 12                        |

**Outline Drawing and Circuit Diagram**

| Dimensions | Inches    | Millimeters |
|------------|-----------|-------------|
| A          | 3.7       | 94.0        |
| B          | 3.15±0.01 | 80.0±0.25   |
| C          | 1.89      | 48.0        |
| D          | 0.94      | 24.0        |
| E          | 0.28      | 7.0         |
| F          | 0.67      | 17.0        |
| G          | 0.91      | 23.0        |
| H          | 0.91      | 23.0        |
| J          | 0.43      | 11.0        |
| L          | 0.16      | 4.0         |

| Dimensions | Inches           | Millimeters    |
|------------|------------------|----------------|
| M          | 0.47             | 12.0           |
| N          | 0.53             | 13.5           |
| O          | 0.1              | 2.5            |
| P          | 0.63             | 16.0           |
| Q          | 0.98             | 25.0           |
| R          | 1.18 +0.04/-0.02 | 30.0 +1.0/-0.5 |
| S          | 0.3              | 7.5            |
| T          | 0.83             | 21.2           |
| U          | 0.16             | 4.0            |
| V          | 0.51             | 13.0           |

## CM75E3U-12H

HIGH POWER SWITCHING USE  
INSULATED TYPEAbsolute Maximum Ratings,  $T_j = 25\text{ }^\circ\text{C}$  unless otherwise specified

| Ratings   | Symbol    | CM75E3U-12H | Units            |
|---|-----------|-------------|------------------|
| Junction Temperature  | $T_j$     | -40 to 150  | $^\circ\text{C}$ |
| Storage Temperature   | $T_{stg}$ | -40 to 125  | $^\circ\text{C}$ |
| Collector-Emitter Voltage (G-E SHORT)   | $V_{CES}$ | 600         | Volts            |
| Gate-Emitter Voltage (C-E SHORT)  | $V_{GES}$ | $\pm 20$    | Volts            |
| Collector Current ( $T_c = 25^\circ\text{C}$ )  | $I_C$     | 75          | Amperes          |
| Peak Collector Current  | $I_{CM}$  | 150*        | Amperes          |
| Emitter Current** ( $T_c = 25^\circ\text{C}$ )  | $I_E$     | 75          | Amperes          |
| Peak Emitter Current**  | $I_{EM}$  | 150*        | Amperes          |
| Maximum Collector Dissipation ( $T_c = 25^\circ\text{C}$ , $T_j \leq 150^\circ\text{C}$ ) | $P_C$     | 310         | Watts            |
| Mounting Torque, M5 Main Terminal   | –         | 2.5~3.5     | N · m            |
| Mounting Torque, M6 Mounting  | –         | 3.5~4.5     | N · m            |
| Weight  | –         | 310         | Grams            |
| Isolation Voltage (Main Terminal to Baseplate, AC 1 min.)                                 | $V_{iso}$ | 2500        | Vrms             |

\* Pulse width and repetition rate should be such that the device junction temperature ( $T_j$ ) does not exceed  $T_{j(max)}$  rating.

\*\*Represents characteristics of the anti-parallel, emitter-to-collector free-wheel diode (FWDi).

Static Electrical Characteristics,  $T_j = 25\text{ }^\circ\text{C}$  unless otherwise specified

| Characteristics                      | Symbol        | Test Conditions   | Min. | Typ. | Max. | Units         |
|--------------------------------------|---------------|---|------|------|------|---------------|
| Collector-Cutoff Current             | $I_{CES}$     | $V_{CE} = V_{CES}$ , $V_{GE} = 0V$                              | –    | –    | 1    | mA            |
| Gate Leakage Voltage                 | $I_{GES}$     | $V_{GE} = V_{GES}$ , $V_{CE} = 0V$                              | –    | –    | 0.5  | $\mu\text{A}$ |
| Gate-Emitter Threshold Voltage       | $V_{GE(th)}$  | $I_C = 7.5\text{mA}$ , $V_{CE} = 10V$                           | 4.5  | 6    | 7.5  | Volts         |
| Collector-Emitter Saturation Voltage | $V_{CE(sat)}$ | $I_C = 75\text{A}$ , $V_{GE} = 15V$ , $T_j = 25^\circ\text{C}$  | –    | 2.4  | 3.0  | Volts         |
|                                      |               | $I_C = 75\text{A}$ , $V_{GE} = 15V$ , $T_j = 125^\circ\text{C}$ | –    | 2.6  | –    | Volts         |
| Total Gate Charge                    | $Q_G$         | $V_{CC} = 300V$ , $I_C = 75\text{A}$ , $V_{GE} = 15V$           | –    | 150  | –    | nC            |
| Emitter-Collector Voltage**          | $V_{EC}$      | $I_E = 75\text{A}$ , $V_{GE} = 0V$                              | –    | –    | 2.6  | Volts         |
| Emitter-Collector Voltage            | $V_{FM}$      | $I_F = 75\text{A}$ , Clamp Diode Part                           | –    | –    | 2.6  | Volts         |

\*\*Represents characteristics of the anti-parallel, emitter-to-collector free-wheel diode (FWDi).

Dynamic Electrical Characteristics,  $T_j = 25\text{ }^\circ\text{C}$  unless otherwise specified

| Characteristics                 | Symbol              | Test Conditions   | Min. | Typ. | Max. | Units         |
|---------------------------------|---------------------|---|------|------|------|---------------|
| Input Capacitance               | $C_{ies}$           |   | –    | –    | 6.6  | nF            |
| Output Capacitance              | $C_{oes}$           | $V_{CE} = 10V$ , $V_{GE} = 0V$  | –    | –    | 3.6  | nF            |
| Reverse Transfer Capacitance    | $C_{res}$           |   | –    | –    | 1    | nF            |
| Resistive                       | Turn-on Delay Time  | $V_{CC} = 300V$ , $I_C = 75\text{A}$ ,<br>$V_{GE1} = V_{GE2} = 15V$ , | –    | –    | 100  | ns            |
|                                 | Rise Time           |   |      |      |      |               |
| Switch                          | Turn-off Delay Time | $R_G = 8.3\Omega$ , Resistive<br>Load Switching Operation             | –    | –    | 200  | ns            |
|                                 | Fall Time           |   |      |      |      |               |
| Diode Reverse Recovery Time**   | $t_{rr}$            | $I_E = 75\text{A}$ , $di_E/dt = -150\text{A}/\mu\text{s}$             | –    | –    | 160  | ns            |
| Diode Reverse Recovery Charge** | $Q_{rr}$            | $I_E = 75\text{A}$ , $di_E/dt = -150\text{A}/\mu\text{s}$             | –    | 0.18 | –    | $\mu\text{C}$ |
| Diode Reverse Recovery Time     | $t_{rr}$            | $I_F = 75\text{A}$ , Clamp Diode Part                                 | –    | –    | 160  | ns            |
| Diode Reverse Recovery Charge   | $Q_{rr}$            | $di_F/dt = -150\text{A}/\mu\text{s}$                                  | –    | 0.18 | –    | $\mu\text{C}$ |

\*\*Represents characteristics of the anti-parallel, emitter-to-collector free-wheel diode (FWDi).

# CM75E3U-12H

HIGH POWER SWITCHING USE  
INSULATED TYPE

## Thermal and Mechanical Characteristics, $T_j = 25\text{ }^\circ\text{C}$ unless otherwise specified

| Characteristics                      | Symbol         | Test Conditions                    | Min. | Typ.  | Max. | Units              |
|--------------------------------------|----------------|------------------------------------|------|-------|------|--------------------|
| Thermal Resistance, Junction to Case | $R_{th(j-c)Q}$ | Per IGBT Module                    | -    | -     | 0.4  | $^\circ\text{C/W}$ |
| Thermal Resistance, Junction to Case | $R_{th(j-c)D}$ | Per FWDi Module                    | -    | -     | 0.9  | $^\circ\text{C/W}$ |
| Thermal Resistance, Junction to Case | $R_{th(j-c)}$  | Clamp Diode Part                   | -    | -     | 0.9  | $^\circ\text{C/W}$ |
| Contact Thermal Resistance           | $R_{th(c-f)}$  | Per Module, Thermal Grease Applied | -    | 0.035 | -    | $^\circ\text{C/W}$ |

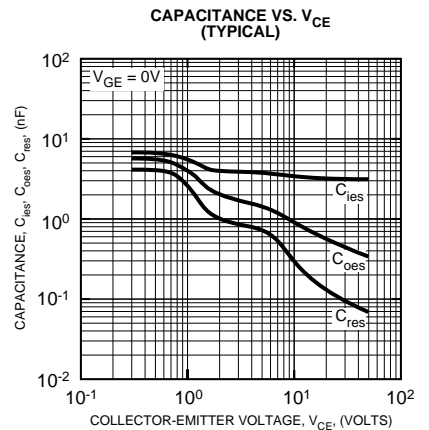
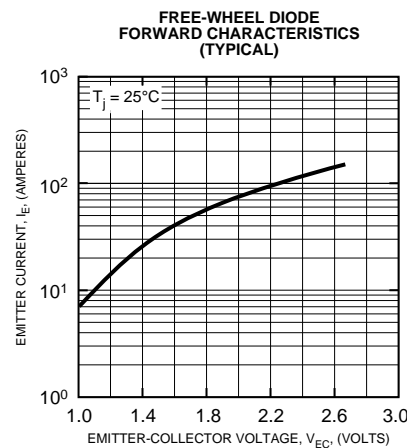
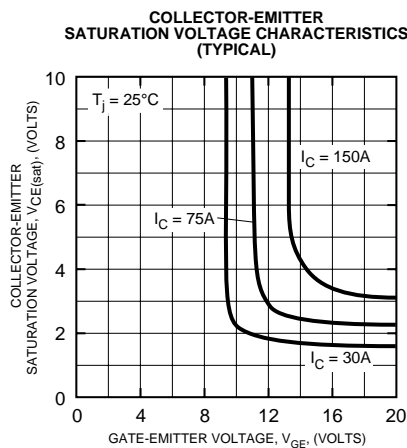
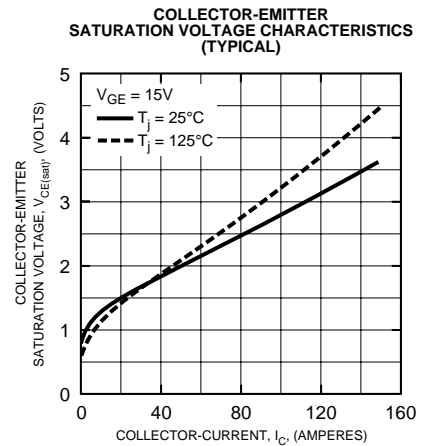
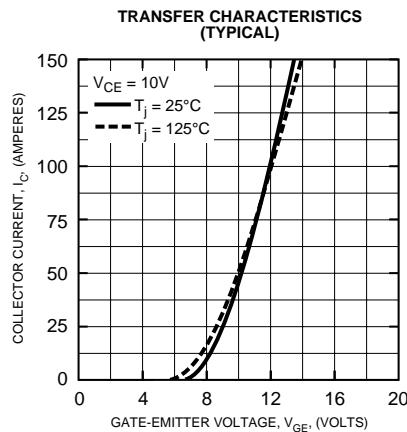
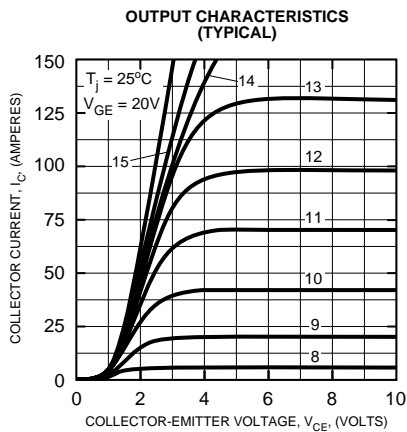

# CM75E3U-12H

HIGH POWER SWITCHING USE  
INSULATED TYPE

**HALF-BRIDGE SWITCHING CHARACTERISTICS (TYPICAL)**

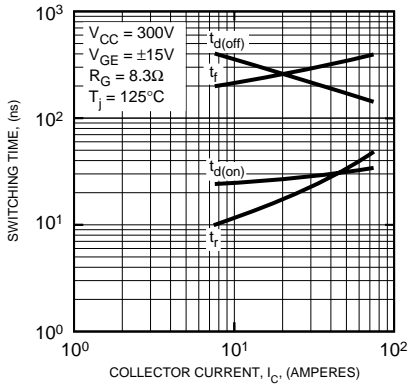

**REVERSE RECOVERY CHARACTERISTICS (TYPICAL)**

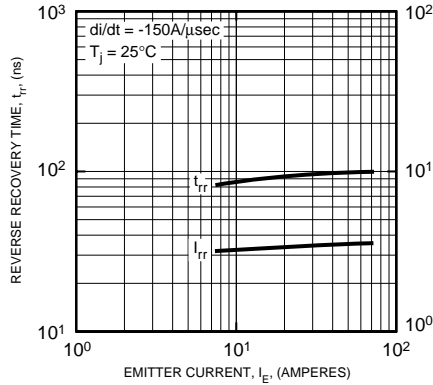

**GATE CHARGE,  $V_{GE}$**

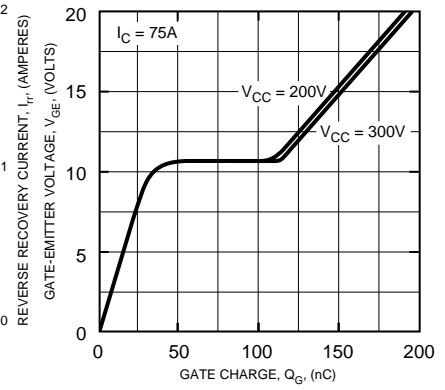

**TRANSIENT THERMAL IMPEDANCE CHARACTERISTICS (IGBT)**

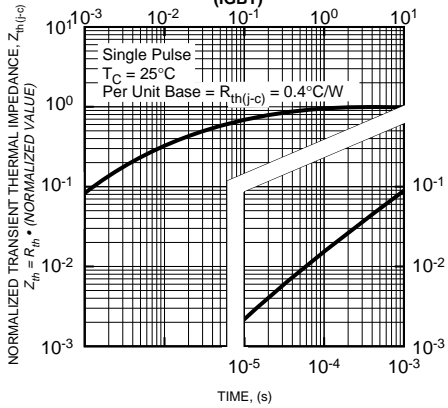

**TRANSIENT THERMAL IMPEDANCE CHARACTERISTICS (FWD)**

