

**Split Dual Si/SiC
 Hybrid IGBT Module
 100 Amperes/1200 Volts**

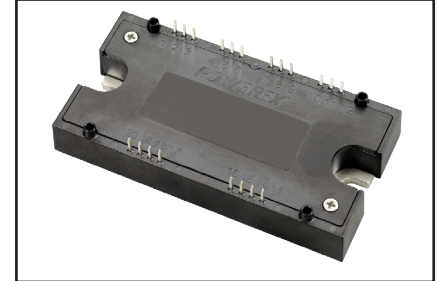
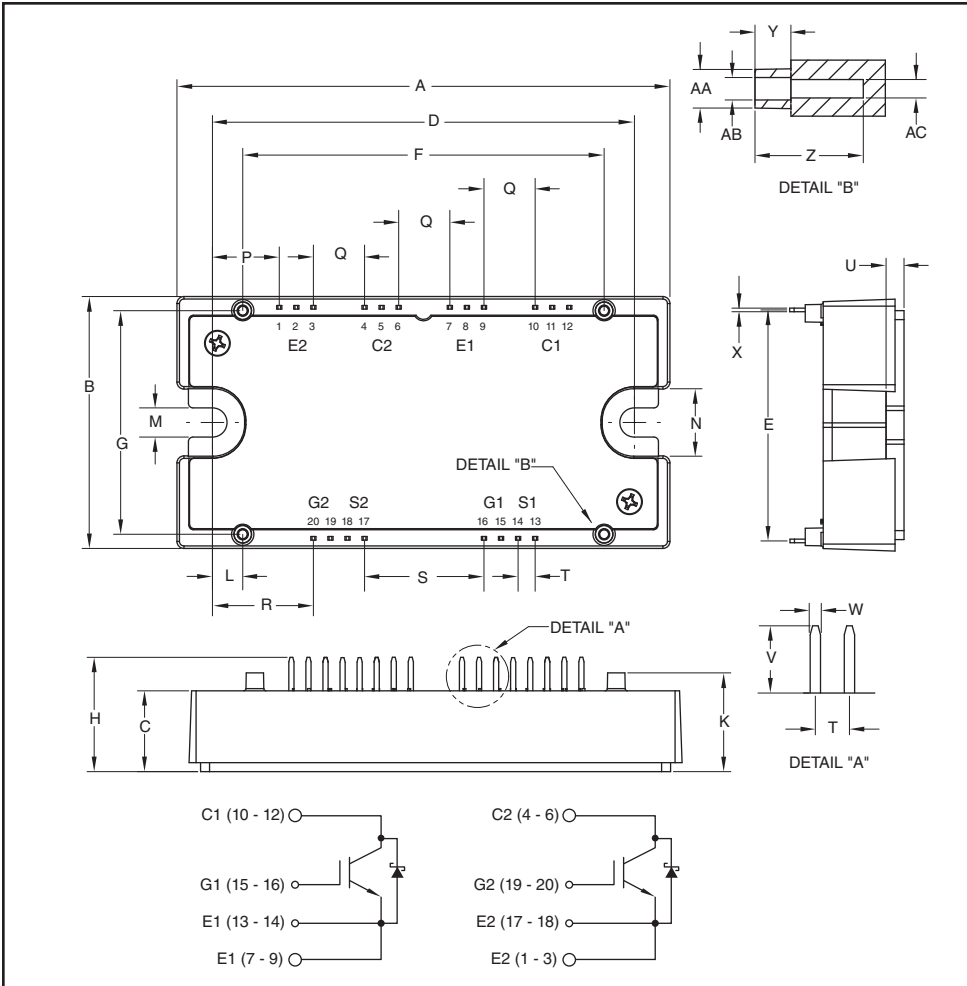

Description:
 Powerex IGBT Modules are designed for use in high frequency applications; upwards of 30 kHz for hard switching applications and 80 kHz for soft switching applications. Each module consists of two IGBT Transistors with each transistor having a reverse-connected super-fast recovery free-wheel silicon carbide Schottky diode. All components and interconnects are isolated from the heat sinking baseplate, offering simplified system assembly and thermal management.

- Features:**
- Low ESW(off)
 - Aluminum Nitride Isolation
 - Discrete Super-Fast Recovery Free-Wheel Silicon Carbide Schottky Diode**

- Low Internal Inductance
- 2 Individual Switches per Module
- Isolated Baseplate for Easy Heat Sinking
- Copper Baseplate

- Applications:**
- Energy Saving Power Systems such as:
Fans; Pumps; Consumer Appliances
 - High Frequency Type Power Systems such as:
UPS; High Speed Motor Drives; Induction Heating; Welder; Robotics
 - High Temperature Power Systems such as:
Power Electronics in Electric Vehicle and Aviation Systems

Outline Drawing and Circuit Diagram

Dimensions	Inches	Millimeters
A	4.32	109.8
B	2.21	56.1
C	0.71	18.0
D	3.70±0.02	94.0±0.5
E	2.026	51.46
F	3.17	80.5
G	1.96	49.8
H	1.00	25.5
K	0.87	22.0
L	0.266	6.75
M	0.26	6.5
N	0.59	15.0
P	0.586	14.89

Dimensions	Inches	Millimeters
Q	0.449	11.40
R	0.885	22.49
S	1.047	26.6
T	0.15	3.80
U	0.16	4.0
V	0.30	7.5
W	0.045	1.15
X	0.03	0.8
Y	0.16	4.0
Z	0.47	12.1
AA	0.17 Dia.	4.3 Dia.
AB	0.10 Dia.	2.5 Dia.
AC	0.08 Dia.	2.1 Dia.

QID1210005
Split Dual Si/SiC Hybrid IGBT Module
 100 Amperes/1200 Volts

Absolute Maximum Ratings, $T_j = 25^\circ\text{C}$ unless otherwise specified

Ratings	Symbol	QID1210005	Units
Junction Temperature	T_j	-40 to 150	$^\circ\text{C}$
Storage Temperature	T_{stg}	-40 to 150	$^\circ\text{C}$
Collector-Emitter Voltage (G-E Short)	V_{CES}	1200	Volts
Gate-Emitter Voltage (C-E Short)	V_{GES}	± 20	Volts
Collector Current ($T_C = 25^\circ\text{C}$)	I_C	100*	Amperes
Peak Collector Current	I_{CM}	200*	Amperes
Emitter Current** ($T_C = 25^\circ\text{C}$)	I_E	80*	Amperes
Repetitive Peak Emitter Current ($T_C = 25^\circ\text{C}$, $t_p = 10\text{ms}$, Half Sine Pulse)**	I_{EM}	455*	Amperes
Maximum Collector Dissipation ($T_C = 25^\circ\text{C}$, $T_j \leq 150^\circ\text{C}$)	P_C	730	Watts
Mounting Torque, M6 Mounting	—	40	in-lb
Weight	—	270	Grams
Isolation Voltage (Main Terminal to Baseplate, AC 1 min.)	V_{ISO}	2500	Volts

IGBT Electrical Characteristics, $T_j = 25^\circ\text{C}$ unless otherwise specified

Characteristics	Symbol	Test Conditions	Min.	Typ.	Max.	Units
Collector-Cutoff Current	I_{CES}	$V_{CE} = V_{CES}$, $V_{GE} = 0\text{V}$	—	—	1.0	mA
Gate Leakage Current	I_{GES}	$V_{GE} = V_{GES}$, $V_{CE} = 0\text{V}$	—	—	0.5	μA
Gate-Emitter Threshold Voltage	$V_{GE(th)}$	$I_C = 10\text{mA}$, $V_{CE} = 10\text{V}$	4.5	6.0	7.5	Volts
Collector-Emitter Saturation Voltage	$V_{CE(sat)}$	$I_C = 100\text{A}$, $V_{GE} = 15\text{V}$, $T_j = 25^\circ\text{C}$	—	5.0	6.5	Volts
		$I_C = 100\text{A}$, $V_{GE} = 15\text{V}$, $T_j = 125^\circ\text{C}$	—	5.0	—	Volts
Total Gate Charge	Q_G	$V_{CC} = 600\text{V}$, $I_C = 100\text{A}$, $V_{GE} = 15\text{V}$	—	450	—	nC
Input Capacitance	C_{ies}		—	—	16	nf
Output Capacitance	C_{oes}	$V_{CE} = 10\text{V}$, $V_{GE} = 0\text{V}$	—	—	1.3	nf
Reverse Transfer Capacitance	C_{res}		—	—	0.3	nf
Inductive	Turn-on Delay Time	$t_{d(on)}$	—	—	TBD	ns
	Rise Time					
Load	Turn-off Delay Time	$t_{d(off)}$	—	—	TBD	ns
	TimeFall Time					

* Pulse width and repetition rate should be such that device junction temperature (T_j) does not exceed $T_{j(max)}$ rating.

**Represents characteristics of the anti-parallel, emitter-to-collector silicon carbide Schottky diode (FWDI).

QID1210005

Split Dual Si/SiC Hybrid IGBT Module

100 Amperes/1200 Volts

Reverse Schottky Diode Characteristics, $T_j = 25\text{ }^\circ\text{C}$ unless otherwise specified

Characteristics	Symbol	Test Conditions	Min.	Typ.	Max.	Units
Diode Forward Voltage	V_{FM}	$I_F = 80\text{A}, V_{GS} = -5\text{V}$	—	1.6	2.0	Volts
		$I_F = 80\text{A}, V_{GS} = -5\text{V}, T_j = 175^\circ\text{C}$	—	2.5	3.2	Volts
Diode Reverse Current	I_R	$V_R = 1200\text{V}$	—	140	800	μA
		$V_R = 1200, T_j = 150^\circ\text{C}$	—	260	1600	μA
Diode Capacitive Charge	Q_C	$V_R = 1200\text{V}, I_F = 80\text{A}, di/dt = 800\text{A}/\mu\text{s}$	—	520	—	nC

Thermal and Mechanical Characteristics, $T_j = 25\text{ }^\circ\text{C}$ unless otherwise specified

Characteristics	Symbol	Test Conditions	Min.	Typ.	Max.	Units
Thermal Resistance, Junction to Case	$R_{th(j-c)Q}$	Per IGBT 1/2 Module,	—	—	0.17	$^\circ\text{C}/\text{W}$
		T_C Reference Point Under Chips				
Thermal Resistance, Junction to Case	$R_{th(j-c)D}$	Per FWDi 1/2 Module, T_C Reference	—	—	0.304	$^\circ\text{C}/\text{W}$
		T_C Reference Point Under Chips				
Contact Thermal Resistance	$R_{th(c-f)}$	Per 1/2 Module, Thermal Grease Applied	—	0.04	—	$^\circ\text{C}/\text{W}$
External Gate Resistance	R_G		3.1	—	31	Ω
Internal Inductance	L_{int}	IGBT Part	—	10	—	nH

QID1210005
Split Dual Si/SiC Hybrid IGBT Module
 100 Amperes/1200 Volts

OUTPUT CHARACTERISTICS (TYPICAL)

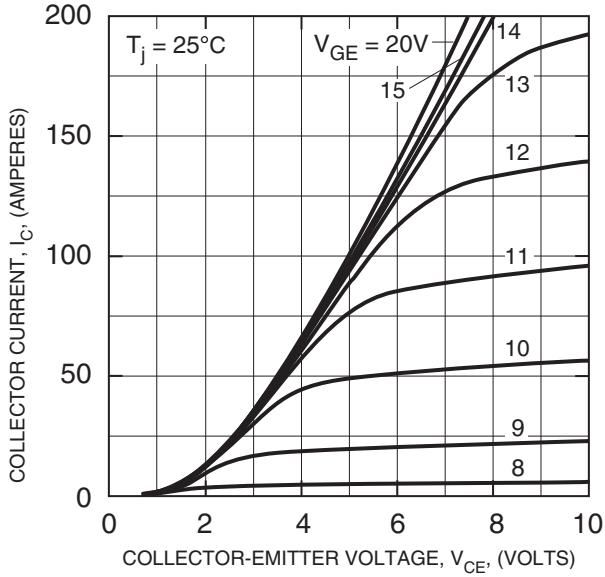

TRANSFER CHARACTERISTICS (TYPICAL)

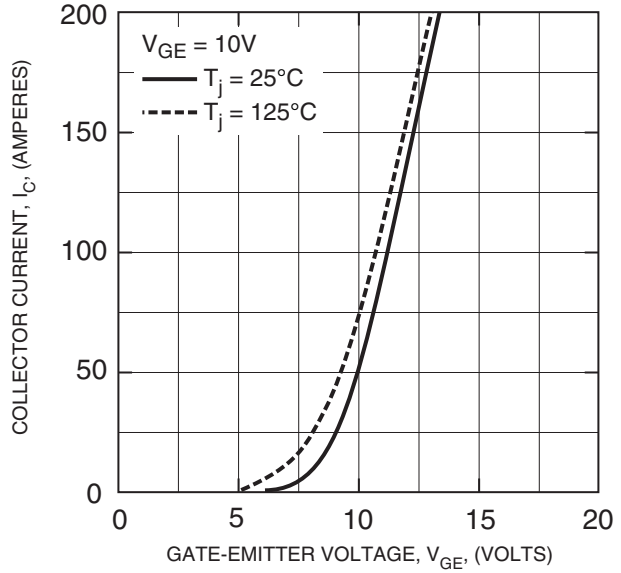

COLLECTOR-EMITTER SATURATION VOLTAGE CHARACTERISTICS (TYPICAL)

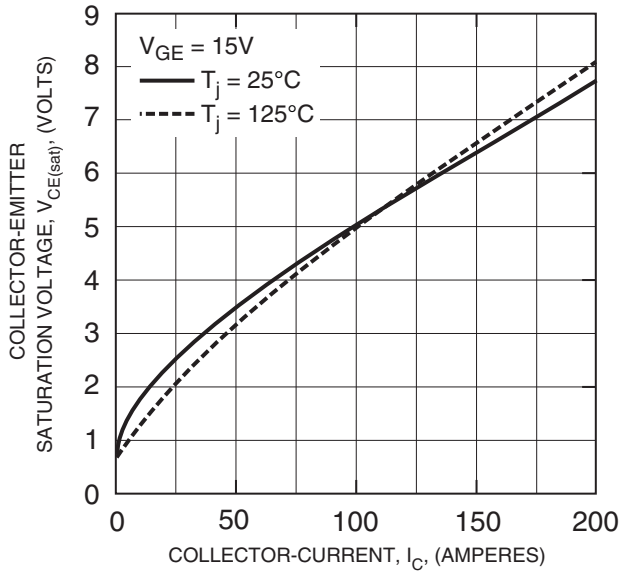

COLLECTOR-EMITTER SATURATION VOLTAGE CHARACTERISTICS (TYPICAL)

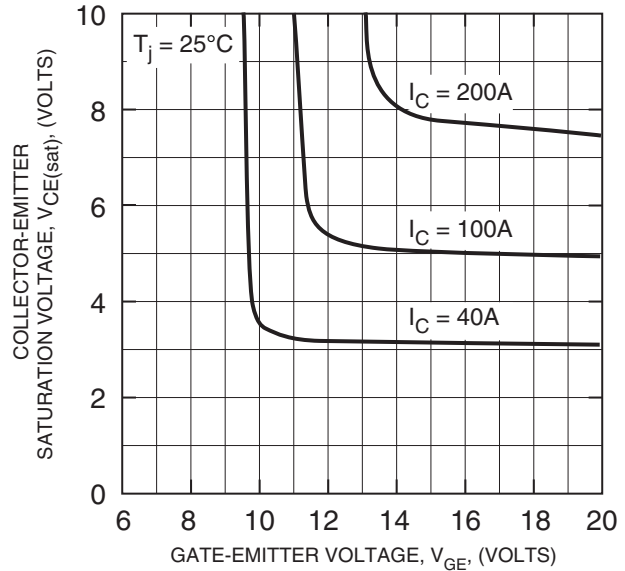

QID1210005
Split Dual Si/SiC Hybrid IGBT Module
 100 Amperes/1200 Volts

FREE-WHEEL SCHOTTKY DIODE FORWARD CHARACTERISTICS (TYPICAL)

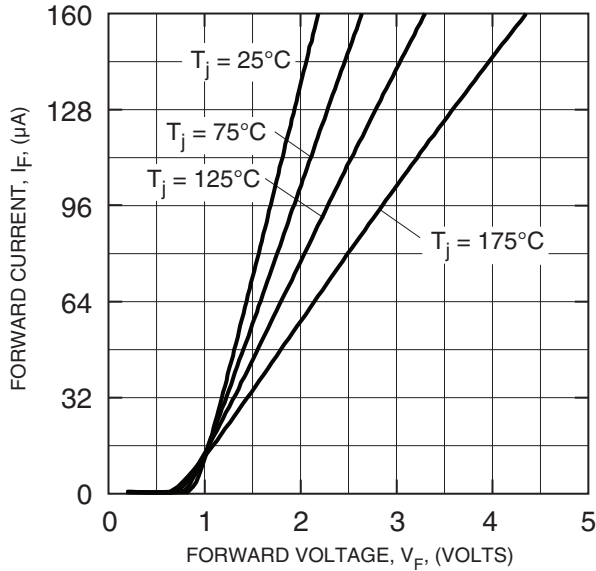

FREE-WHEEL SCHOTTKY DIODE REVERSE CHARACTERISTICS (TYPICAL)

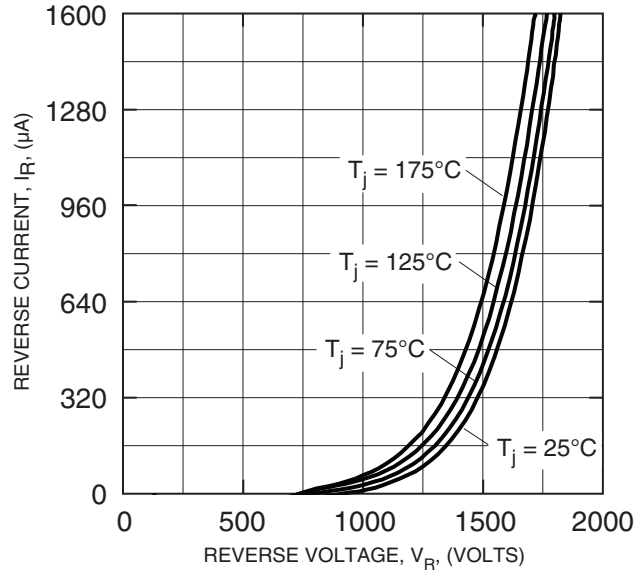

CAPACITANCE VS. V_{CE} (TYPICAL)

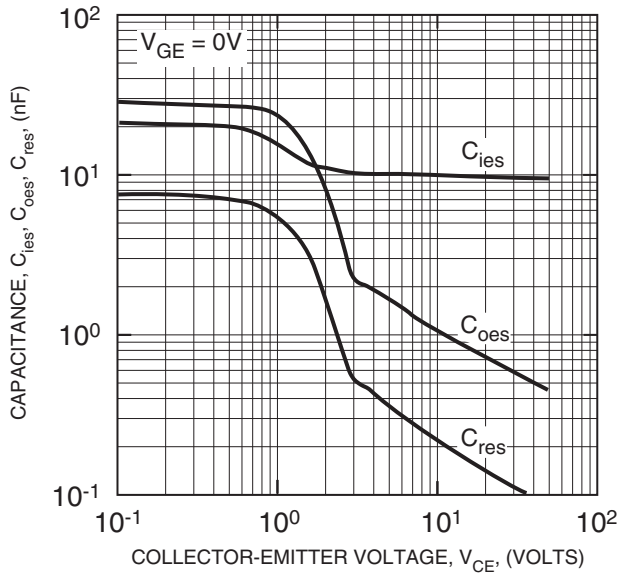

HALF-BRIDGE SWITCHING CHARACTERISTICS (TYPICAL)

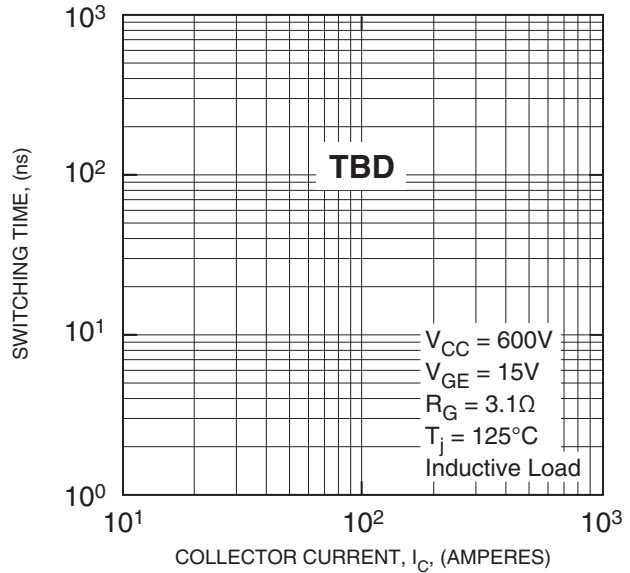

QID1210005
Split Dual SiSiC Hybrid IGBT Module
 100 Amperes/1200 Volts

GATE CHARGE VS. V_{GE}

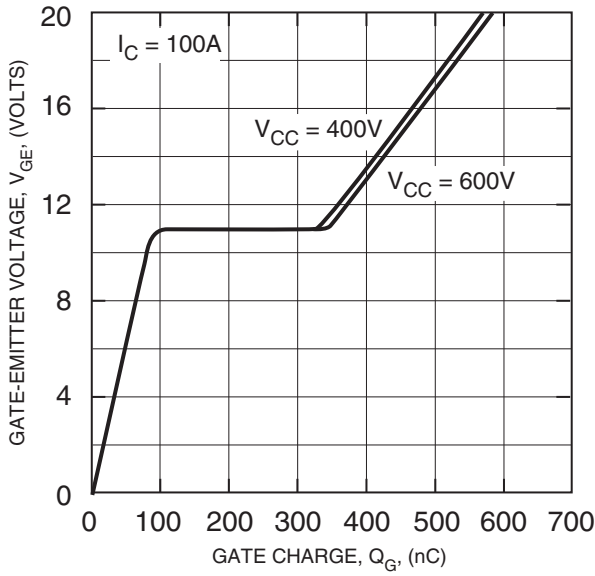

SWITCHING LOSS VS. COLLECTOR CURRENT (TYPICAL)

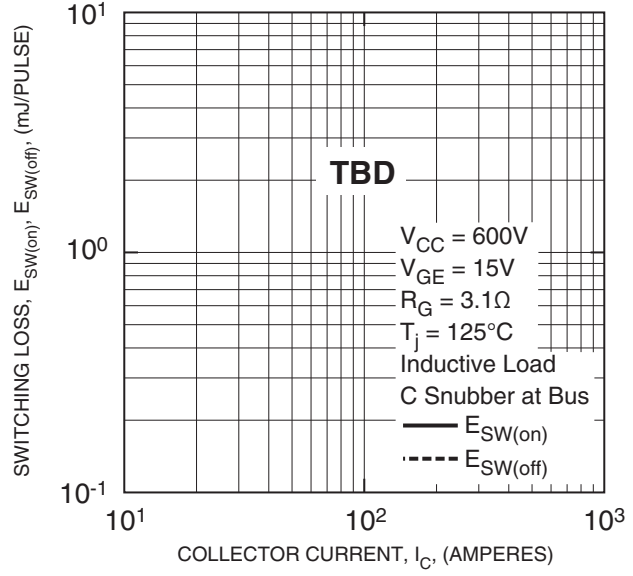

SWITCHING LOSS VS. GATE RESISTANCE (TYPICAL)

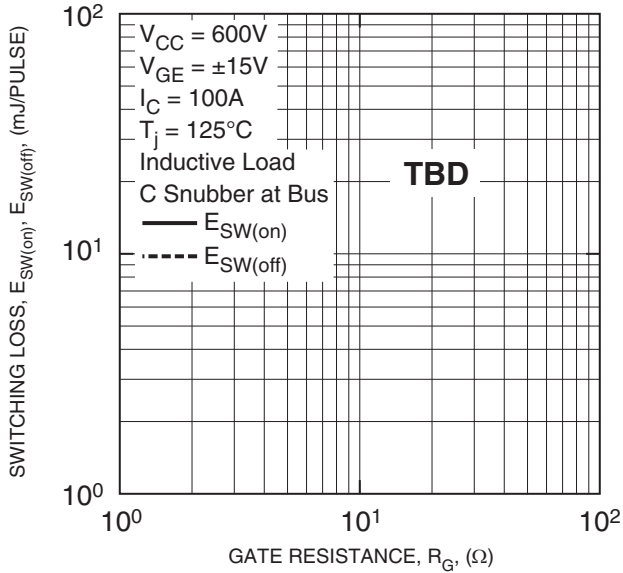

REVERSE RECOVERY SWITCHING LOSS VS. EMITTER CURRENT (TYPICAL)

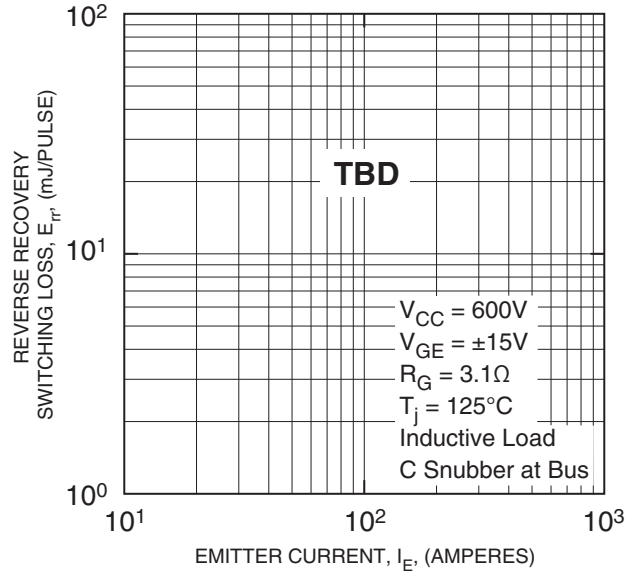

QID1210005
Split Dual Si/SiC Hybrid IGBT Module
 100 Amperes/1200 Volts

REVERSE RECOVERY SWITCHING LOSS VS. GATE RESISTANCE (TYPICAL)

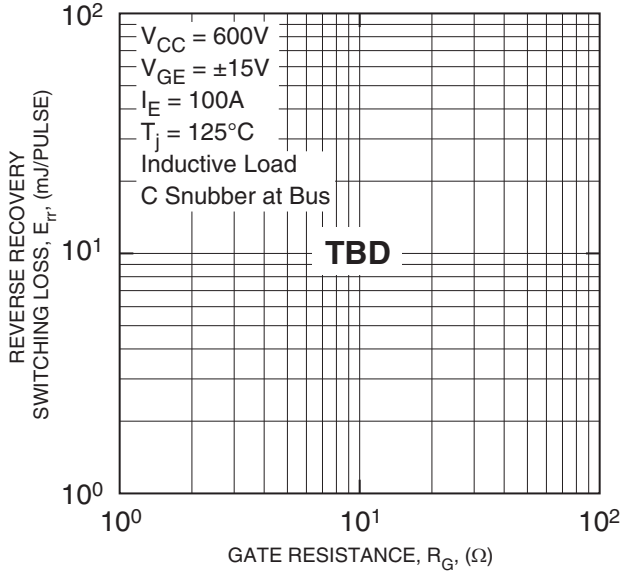

TRANSIENT THERMAL IMPEDANCE CHARACTERISTICS (IGBT & FWDi)

